

Service Manual

High Temperature Hydro Module



SMK-D140HHN1-3

CONTENTS

1 External Appearance	3
2 Nomenclature	3
3 System Schematic	4
4 Specifications	5
5 Electric Control Box Layout	6
6 Working Range.....	11
7 Refrigerant Flow Diagrams	12
8 High Temperature Hydraulic Module Control Logic.....	16
9 Appearance of the Wired Controller	23
10 Status Icons.....	24
11 Using Home Pages.....	25
12 Basic Application.....	33
13 Functions	41
14 Menu Structure Overview	77
15 Maintenance.....	78
16 Error Code Table.....	79
17 Accessories	80

1 External Appearance

Figure 1.1: Appearance



2 Nomenclature

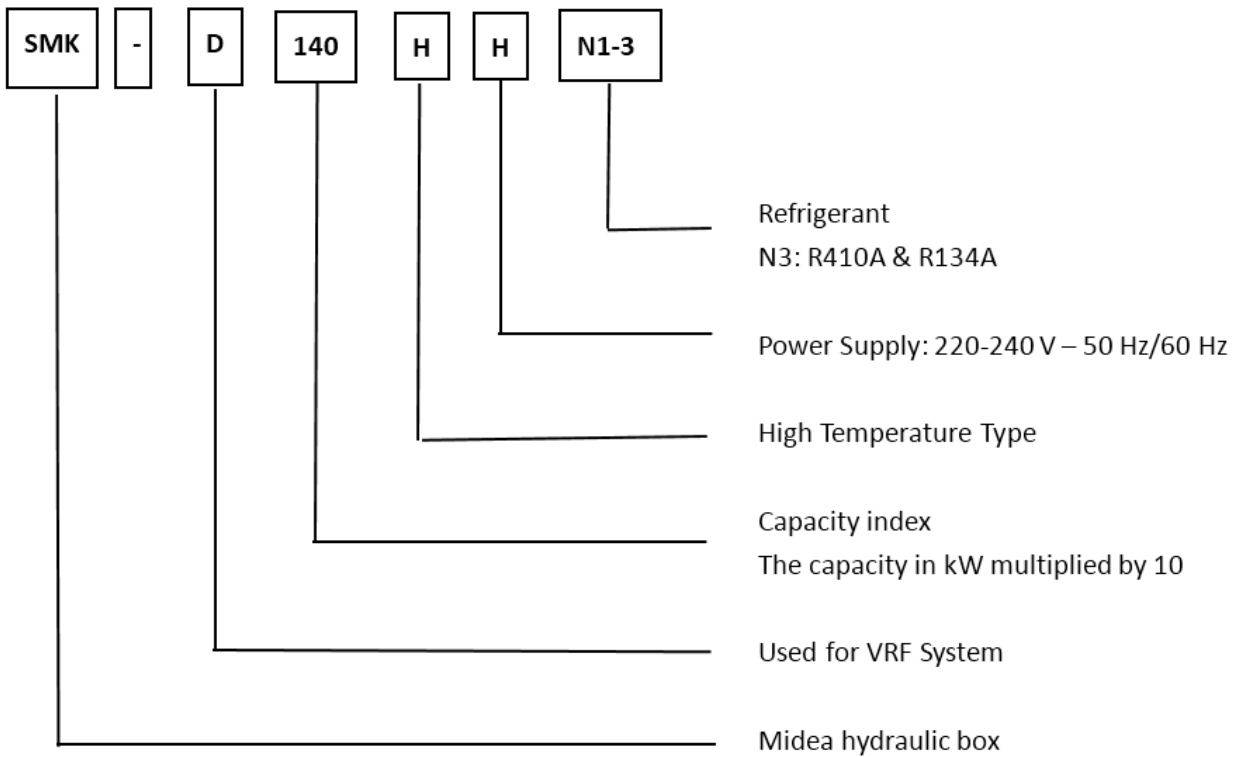

3 System Schematic

Figure 3.1: Hydraulic box connection method

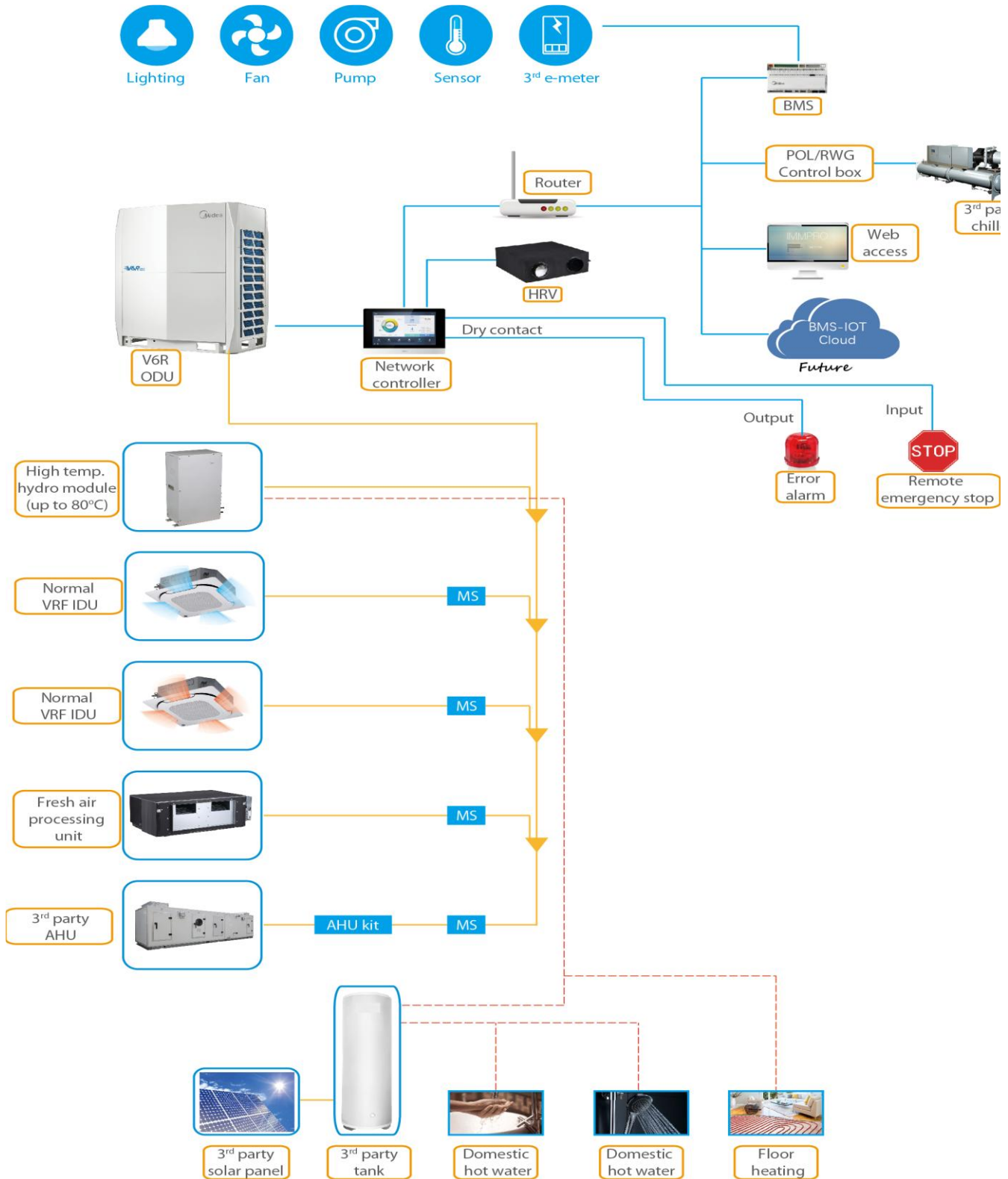

Midea VR High Temperature Hydro Module

4 Specifications

SMK- D140HHN1-3			
Power supply			1P~ 220-240V 50/60Hz
Heating Capacity	7/6°C OAT WIT: 40 / WOT: 45 °C	kW	14
Working range heating	HEAT	/	-20°C~30°C
	DHW	/	-20°C~43°C
ambient temperature range	/	/	0°C~40°C
sound pressure level	/	dB	43
water flow rate	nominal	m ³ /h	2.4
	min	m ³ /h	1.2
	max	m ³ /h	2.9
allowable water pressure	min	MPa	0.1
	max	MPa	1.0
Unit dimensions	Height	mm	795
	Width	mm	450
	Depth	mm	300
Refrigerant pipes connection	Connection type		External Screw Thread
	Liquid pipe diameter	mm	Ø9.52
	Gas pipe diameter	mm	Ø12.7
water pipes connection	Connection type		External Screw Threads
	Inlet pipe diameter	mm	25
	Outlet pipe diameter	mm	25

5 Electric Control Box Layout

Electric Control Box



Inverter Module



Main PCB



5.1 Main PCB

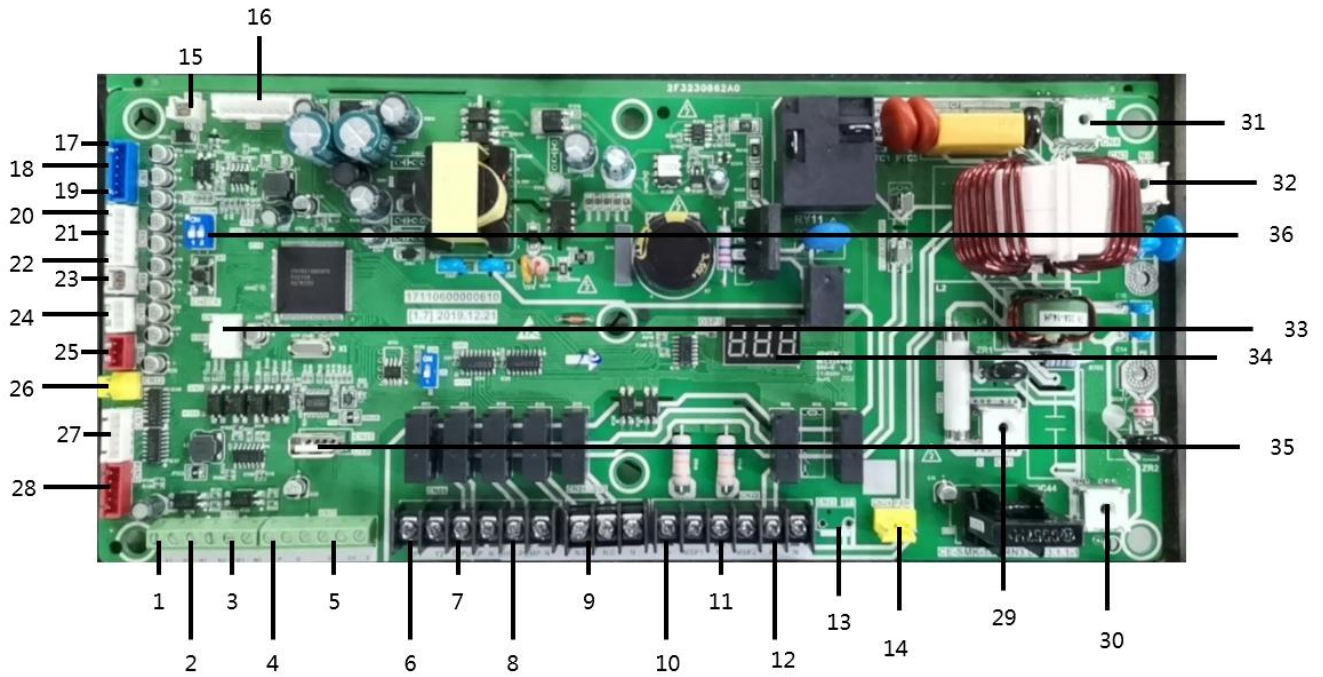

NO.	Port code	Port code	Content	Port voltage
1	X1X2	CN15	Port for communication with wired controller	0 or 18VDC
2	N1N2		Port for signal of free electricity	0 or 12VDC
3	M1M2		Port for signal of valley electricity	0 or 12VDC
4	PQ	CN17	Port for communication with outdoor unit	2.5-2.7VDC
5	D1D2E		Port for communication with KNX gateway or port for communication with slave hydro box (group control)	2.5-2.7VDC
6	Y1Y2	CN20	Reserved	\
7	C-PUMP N		Port for circulating pump	220V AC
8	DHW-PUMP N		Port for DHW pump	220V AC
9	SV3	CN21	Port for three way valve(NC. N for normal close valve, NO. N for normal open valve)	220V AC
10	N MLSP1	CN22	Port for multiple set point 1	220V AC
11	N MLSP2		Port for multiple set point 2	220V AC
12	AL. N		Reserved	\
13	ST	CN23	Reserved	\

NO.	Port code	Port code	Content	Port voltage
13	ST	CN23	Reserved	\
14	FAN	CN24	Pot for fan	220V AC
15	OD	CN6	Port for communication with PC	2.5-2.7VDC
16	FS	CN5	Port for water flow switch	0 or 12VD
17	Twin	CN7	Port for outlet water temperature sensor	0-5V DC(varying)
18	Twout		Port for inlet water temperature sensor	0-5V DC(varying)
19	Ttank		Port for water tank temperature sensor	0-5V DC(varying)
20	T7	CN8	Port for suction pipe temperature sensor	0-5V DC(varying)
21	T2A		Port for R410a circle liquid pipe temperature sensor	0-5V DC(varying)
22	T3		Port for R134a circle liquid pipe temperature sensor	0-5V DC(varying)
23	T7C	CN9	Port for discharge pipe temperature sensor	0-5V DC(varying)
24	H-YL	CN10	Port for high pressure sensor	0-5V DC(varying)
25	L-YL	CN11	Port for low pressure sensor	0-5V DC(varying)
26	H-Pro	CN12	Port for high pressure switch	0 or 5V DC
27	EEV2	CN13	Port for electronic expansion valve 2	0 or 12V DC
28	EEV1	CN14	Port for electronic expansion valve 1	0 or 12V DC
29	L	CN1	Power supply port for main PCB (L)	220V AC
30	N	CN2	Power supply port for main PCB (N)	220V AC
31	L-1	CN4	Power supply port for inverter PCB (L)	220V AC
32	N-1	CN3	Power supply port for inverter PCB (N)	220V AC
33	DEBUG	CN30	Port for IC programming	0-5V DC(varying)
34	DSP1	DSP1	Digital display	\
35	USB	CN25	USB port for IC programming	0-5V DC(varying)
36	SW4	SW4	DIP switch	\

Inverter Module

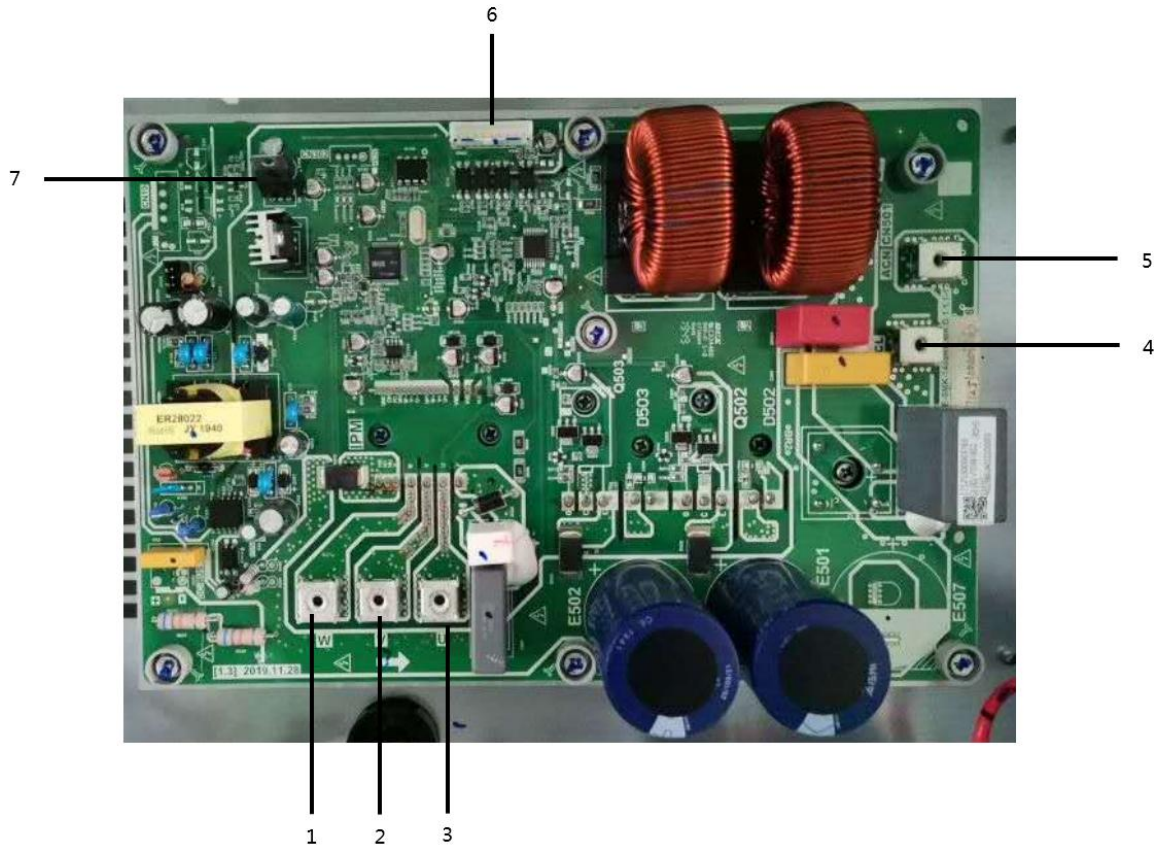

NO.	Port code	Port code	Content	Port voltage
1	/	U	Compressor connection port U	380V AC
2	/	V	Compressor connection port V	380V AC
3	/	W	Compressor connection port W	380V AC
4	ACL	CN502	Power supply port for inverter PCB (L)	310V AC
5	ACN	CN501	Power supply port for inverter PCB (N)	310V AC
6	/	CN32	Communication with main PCB	0-5V DC(varying)
7	/	IC315	EEPROM	\

Installation Cables

Midea VR High Temperature Hydro Module

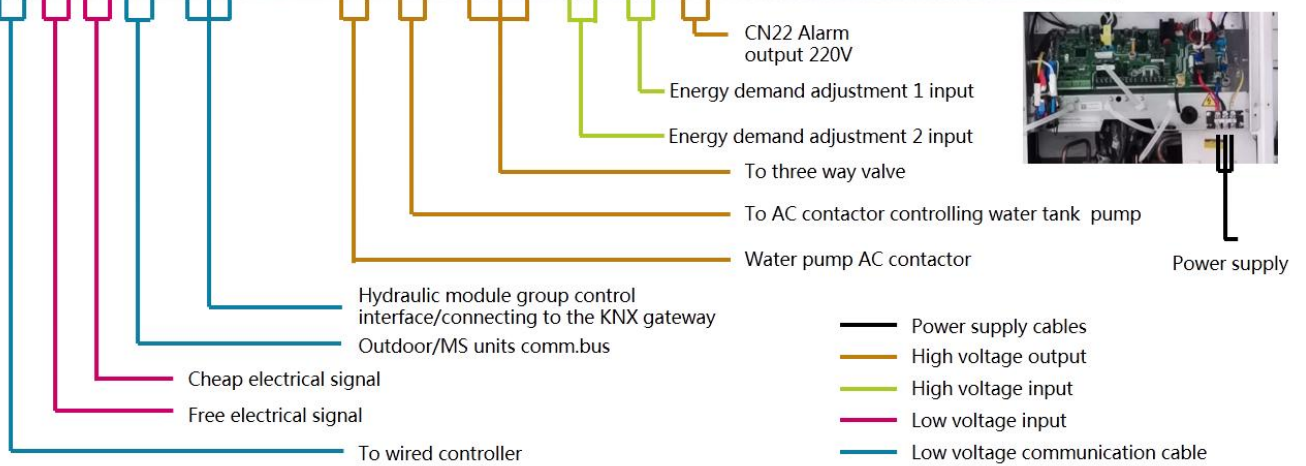
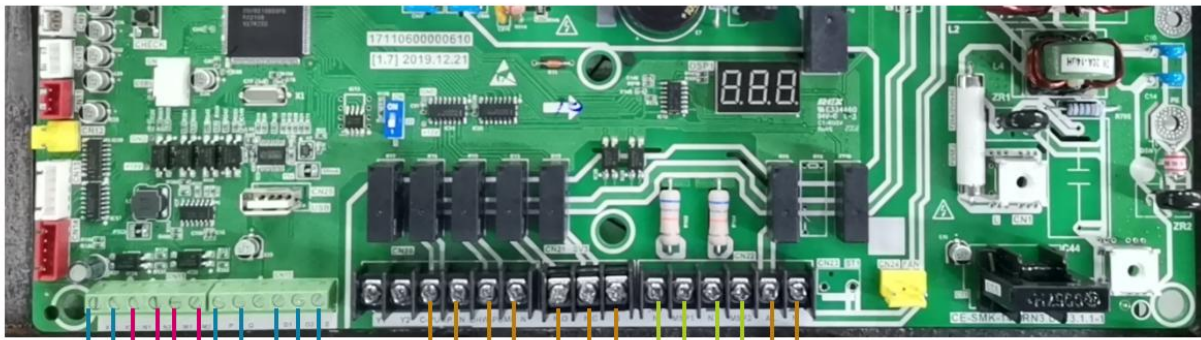

6 Working Range

Heating Mode

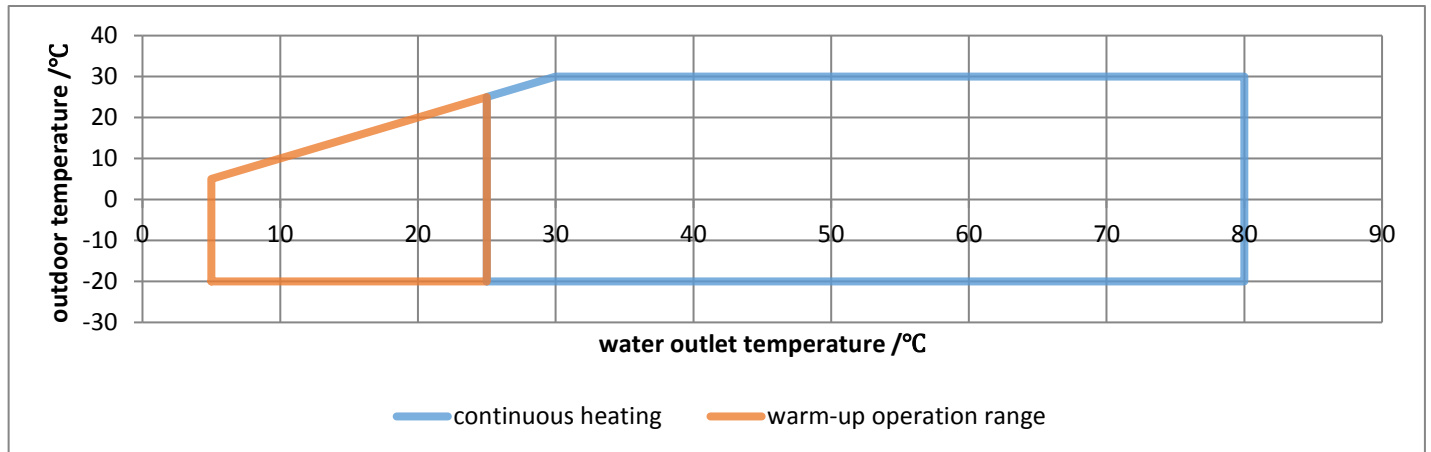

DHW Mode

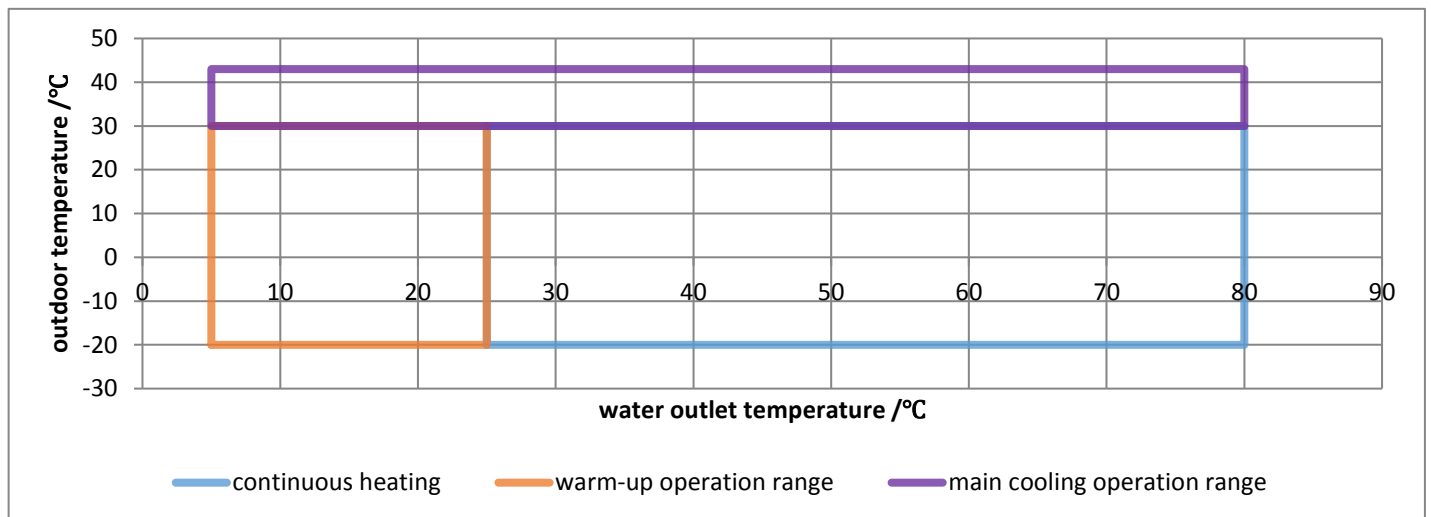

7 Refrigerant Flow Diagrams

ONLY HEATING

Indoor heating + Hydro box

Or only Hydro box

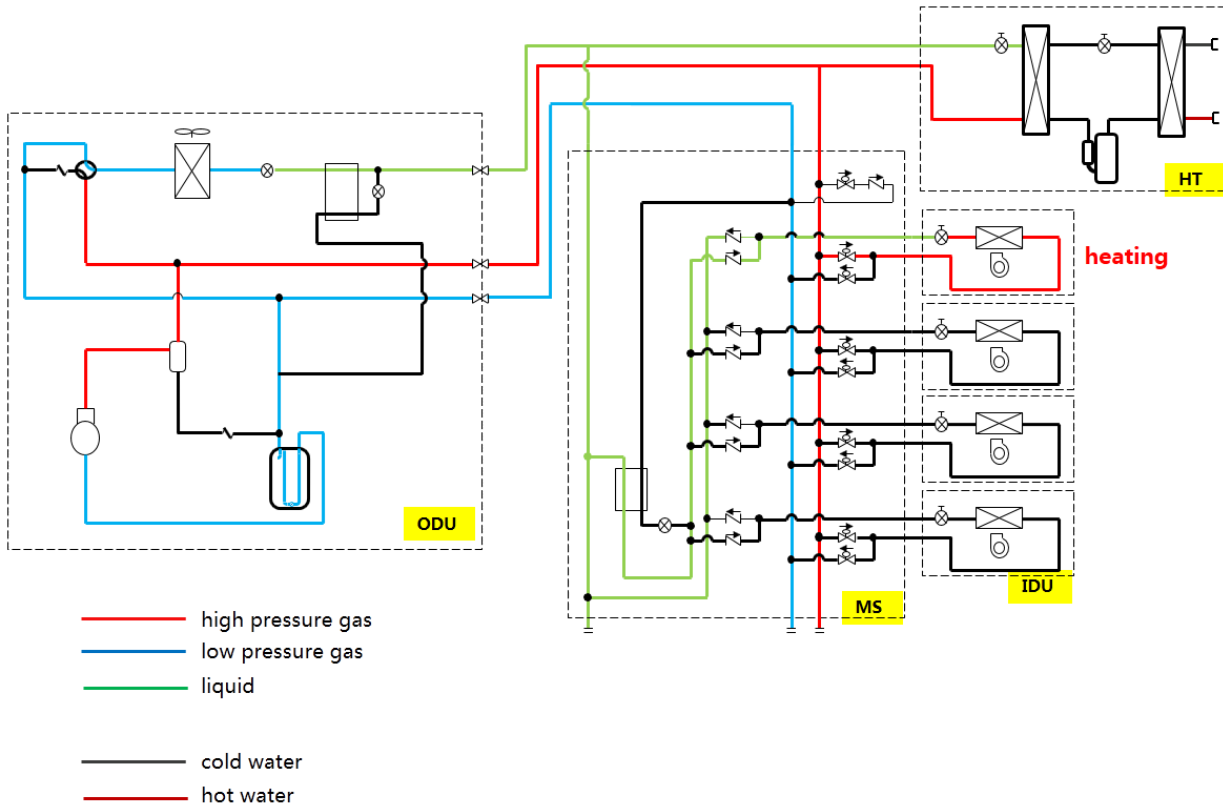

Midea VR High Temperature Hydro Module

MAIN HEATING (Outdoor heat exchanger works as evaporator)

Indoor units in cooling mode +Hydro box

Indoor units in cooling/heating + Hydro box

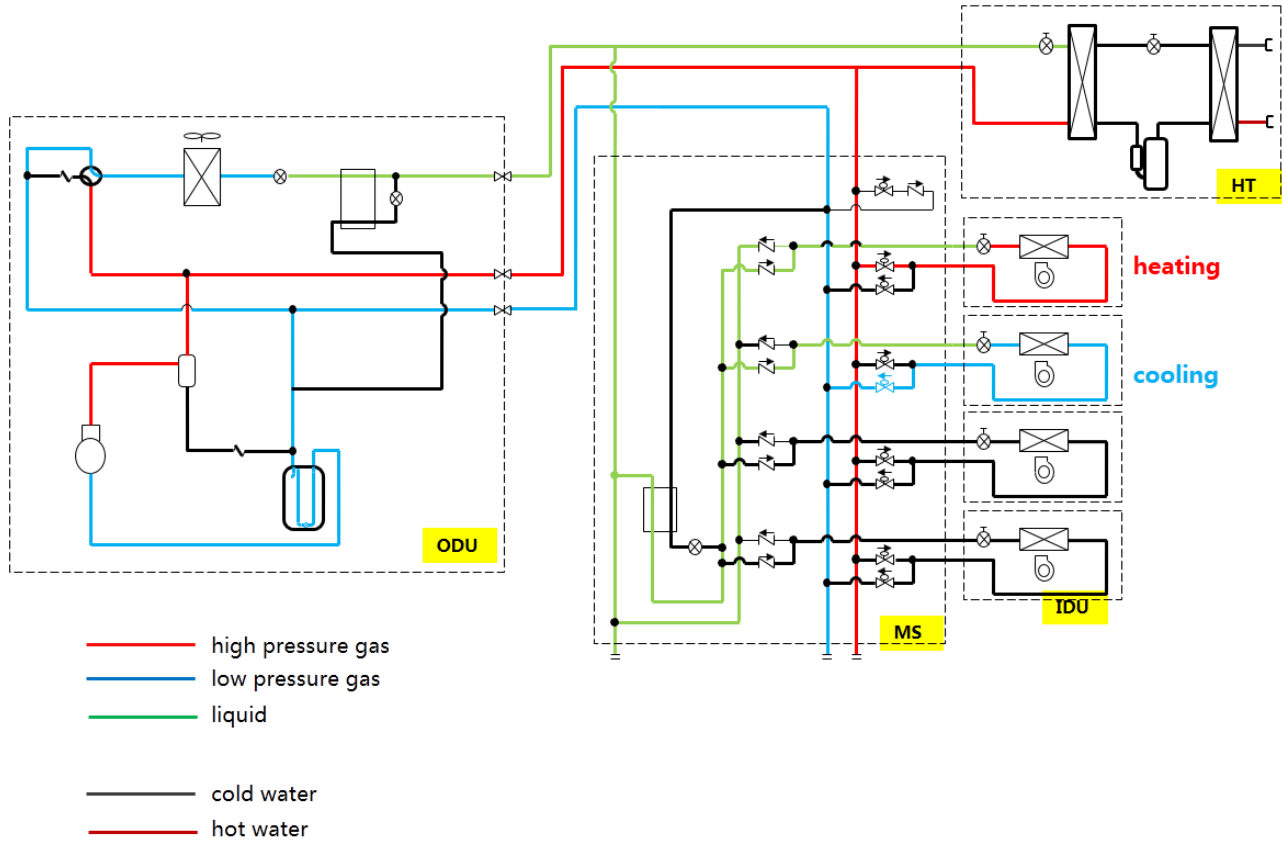

High Temperature Hydro Module

MAIN COOLING (Outdoor heat exchanger works as evaporator)

Indoor units in cooling mode +Hydro box

Indoor units in cooling/heating + Hydro box

Midea VR High Temperature Hydro Module

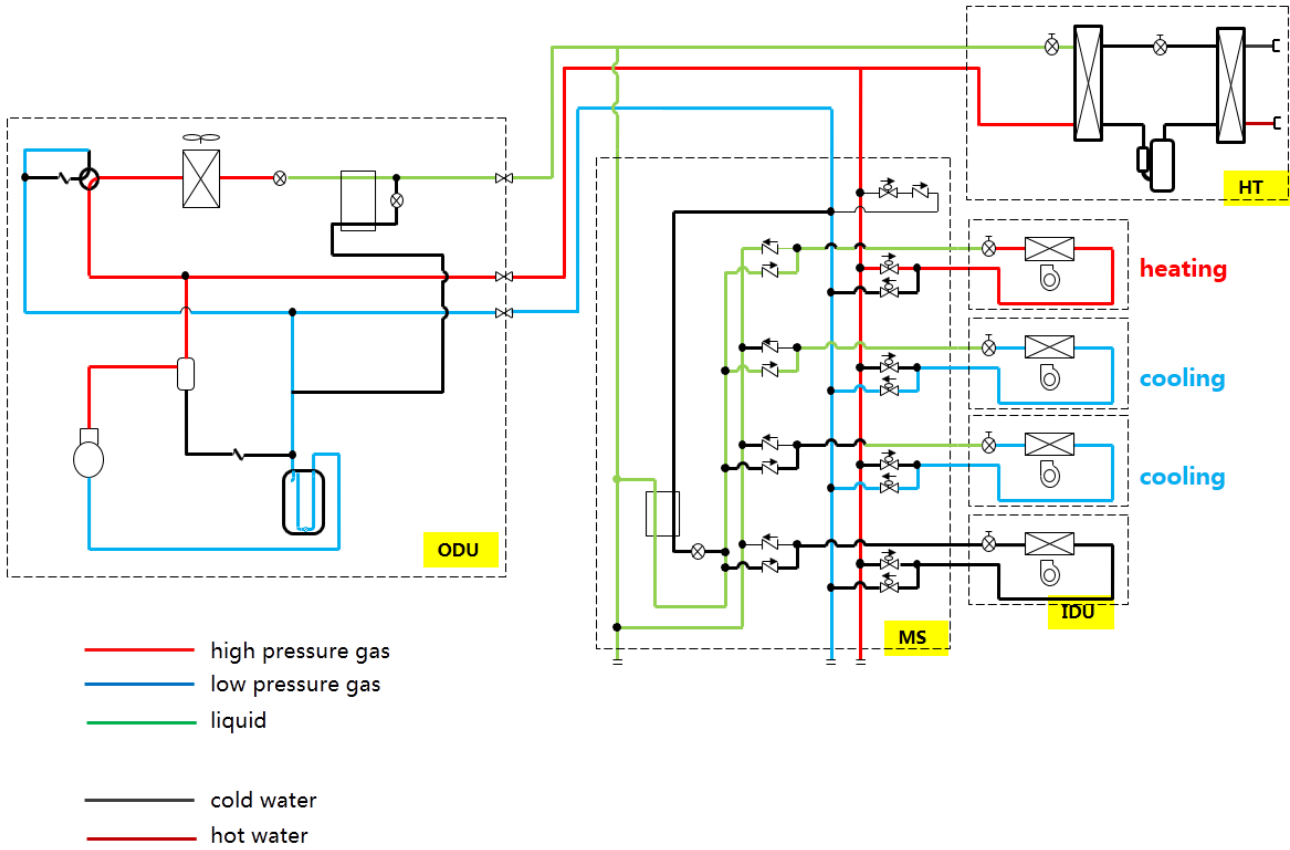

HEAT RECOVERY (Free to provide hot water)

All indoor units in cooling mode + Hydro box

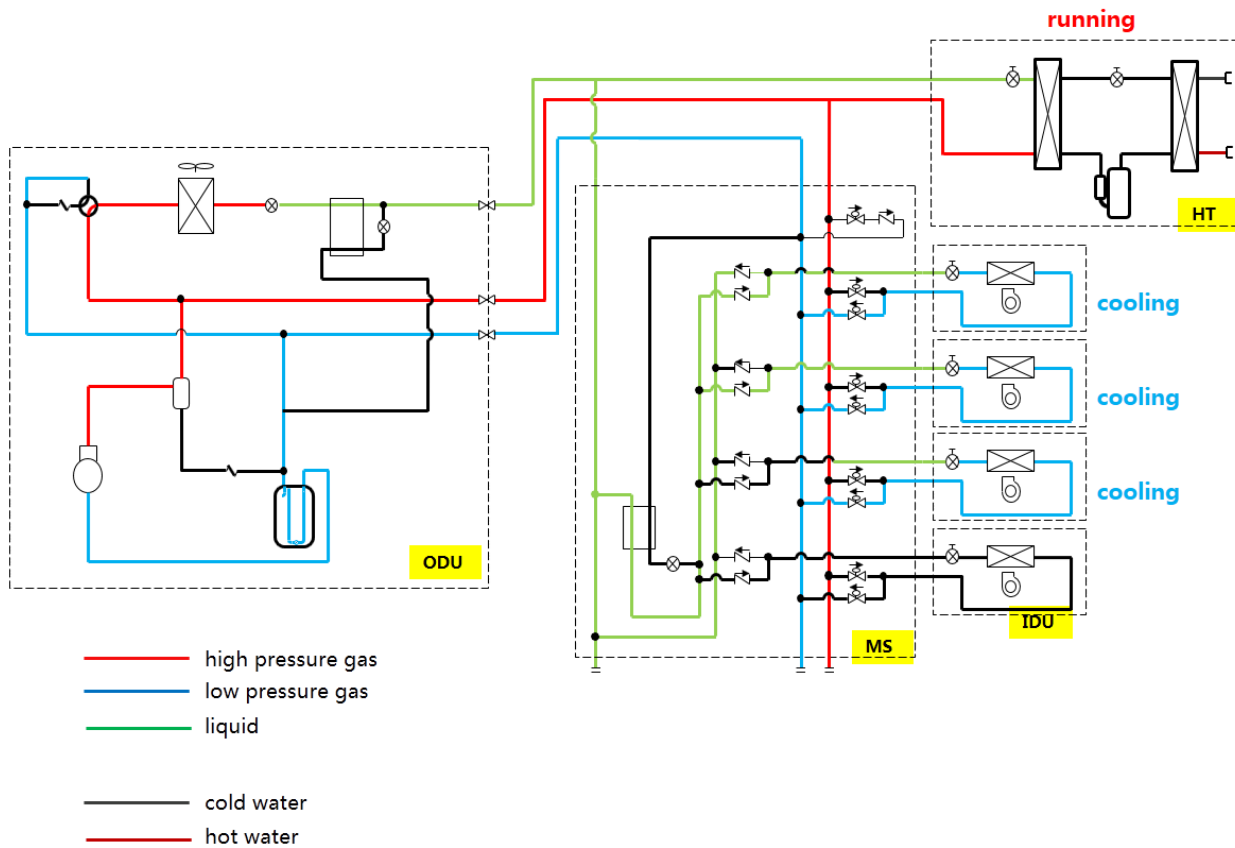

8 High Temperature Hydraulic Module Control Logic

8.1 Start/Stop/ Mode Change

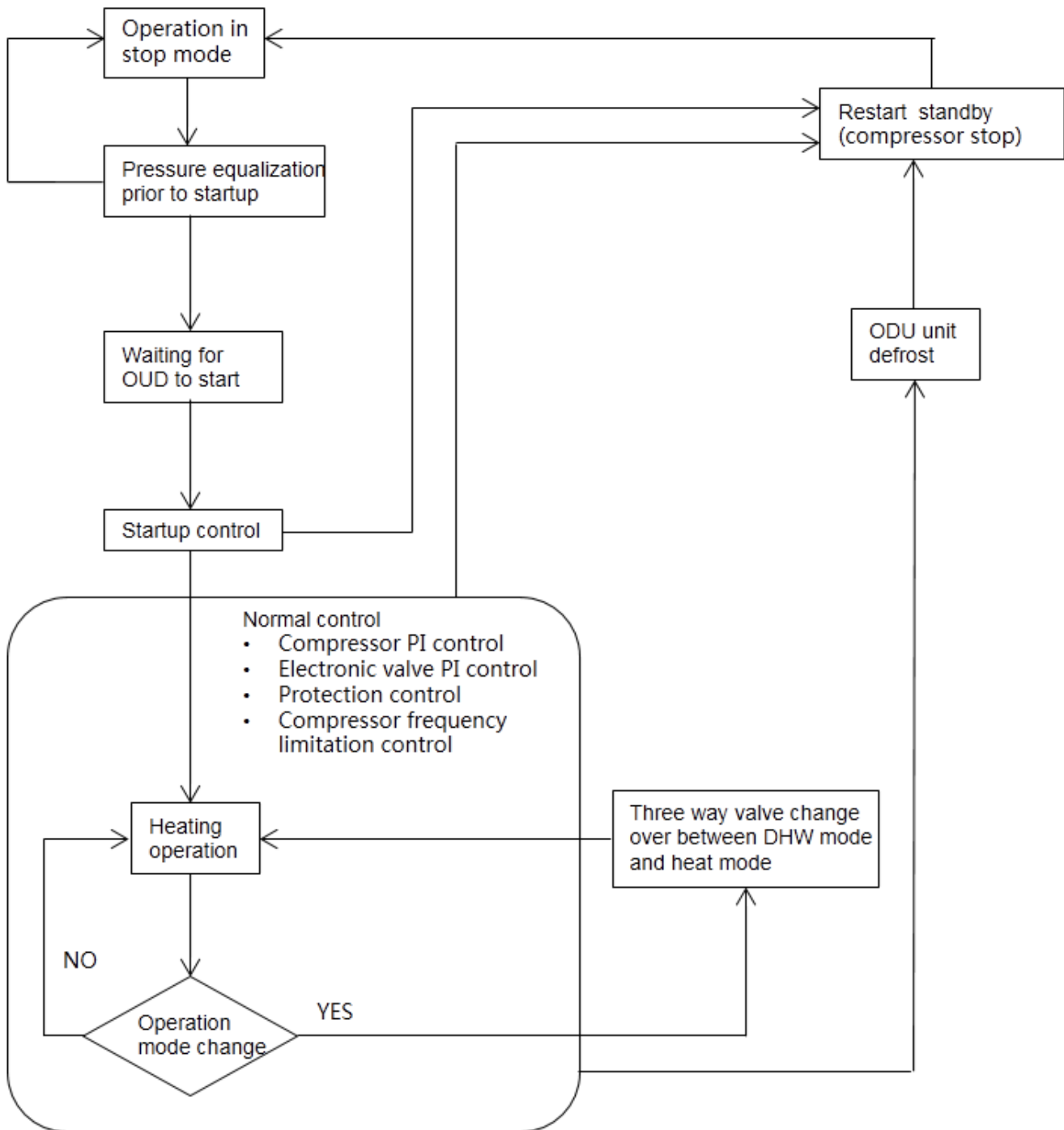

Midea VR High Temperature Hydro Module

8.2 High Temperature Hydraulic Module Control Principle

8.2.1 Compressor Control

The compressor frequency is calculated according to the deviation between T_c and T_{cs} .

T_c : Measured high pressure saturation temperature

T_{cs} : Target high pressure saturation temperature

8.2.2 EXV1 Control

EXV1 opening degree is calculated according to the deviation of $DSH = T7C - T_c$ from the $DSHS$

$DSH = T7C - T_c$: measured discharge superheat

$DSHS$: Target discharge superheat

8.2.3 EXV 2 Control

EXV2 open degree is calculated according to the deviation of $SC = t_c - t_{2a}$ from SCS .

SC : Measured supercooling from the outlet copper pipe of plate heat exchanger

SCS : Target supercooling from the outlet copper pipe of plate heat exchanger

8.2.4 Frequency Limit and Protection Control

High Pressure limits the frequency

Midea VR High Temperature Hydro Module

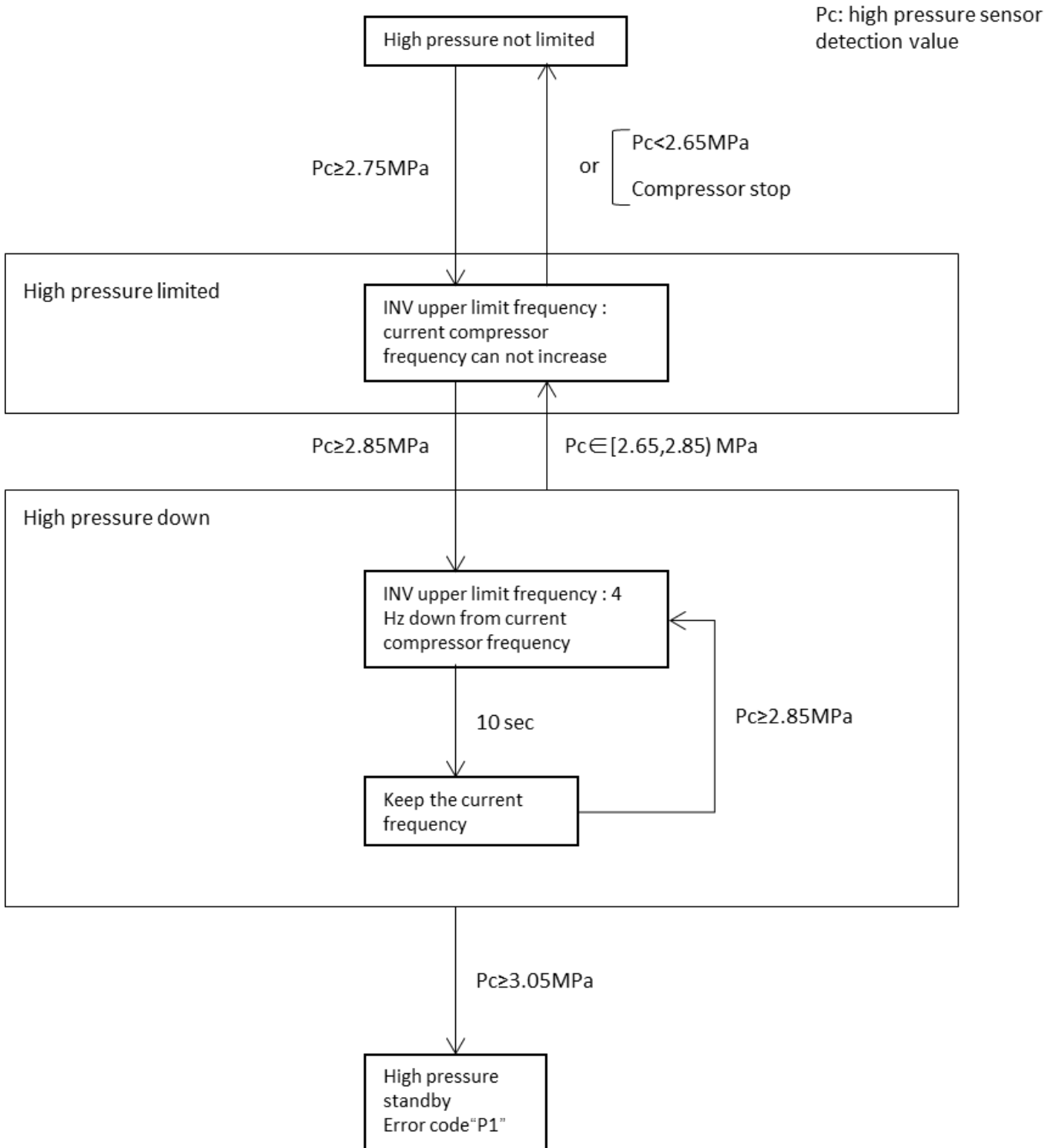

Low Pressure limits the frequency

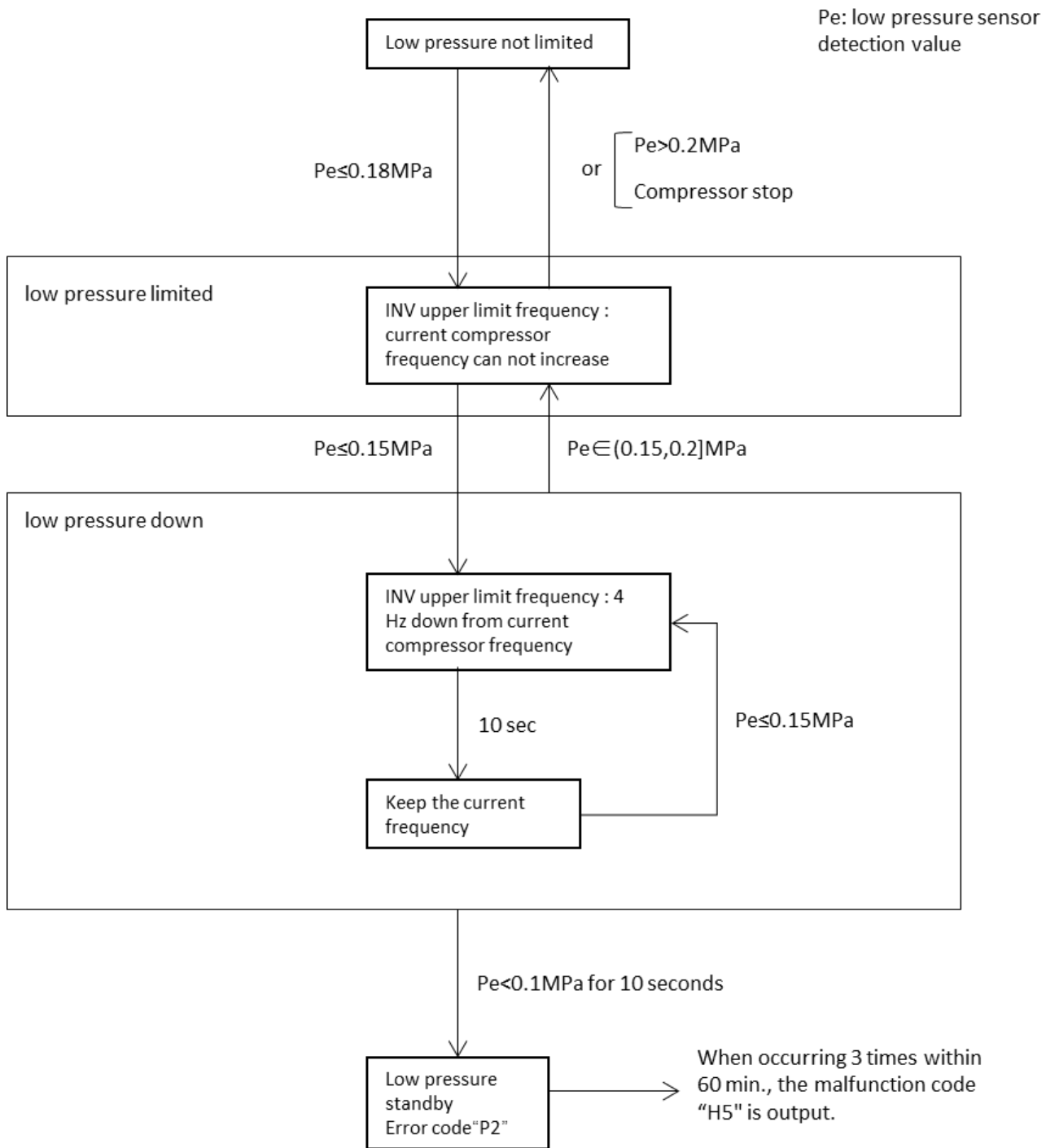

High Temperature Hydro Module



Discharge Temperature Limits the frequency protection

Midea VR High Temperature Hydro Module

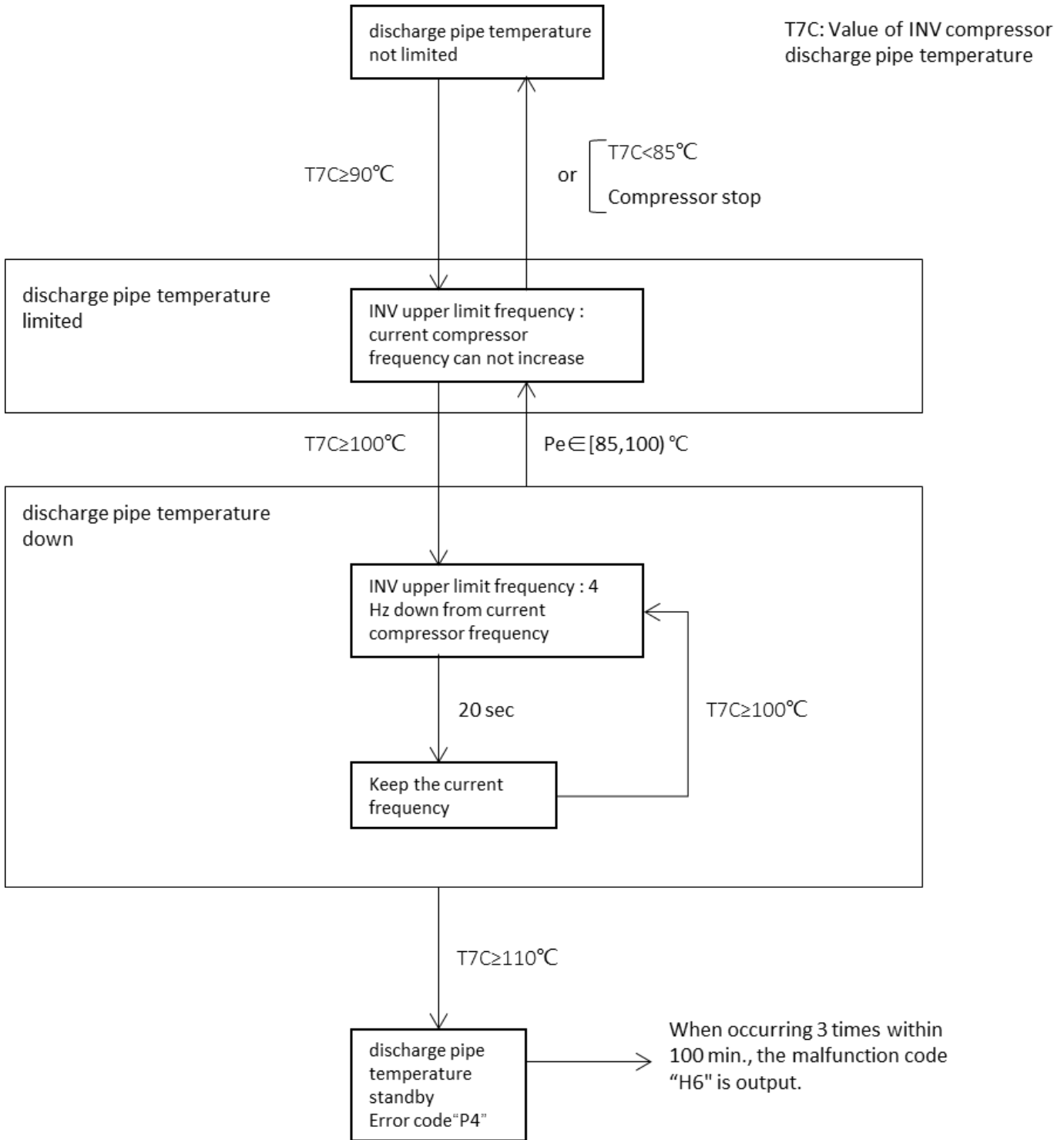

Compressor current limits the frequency protection

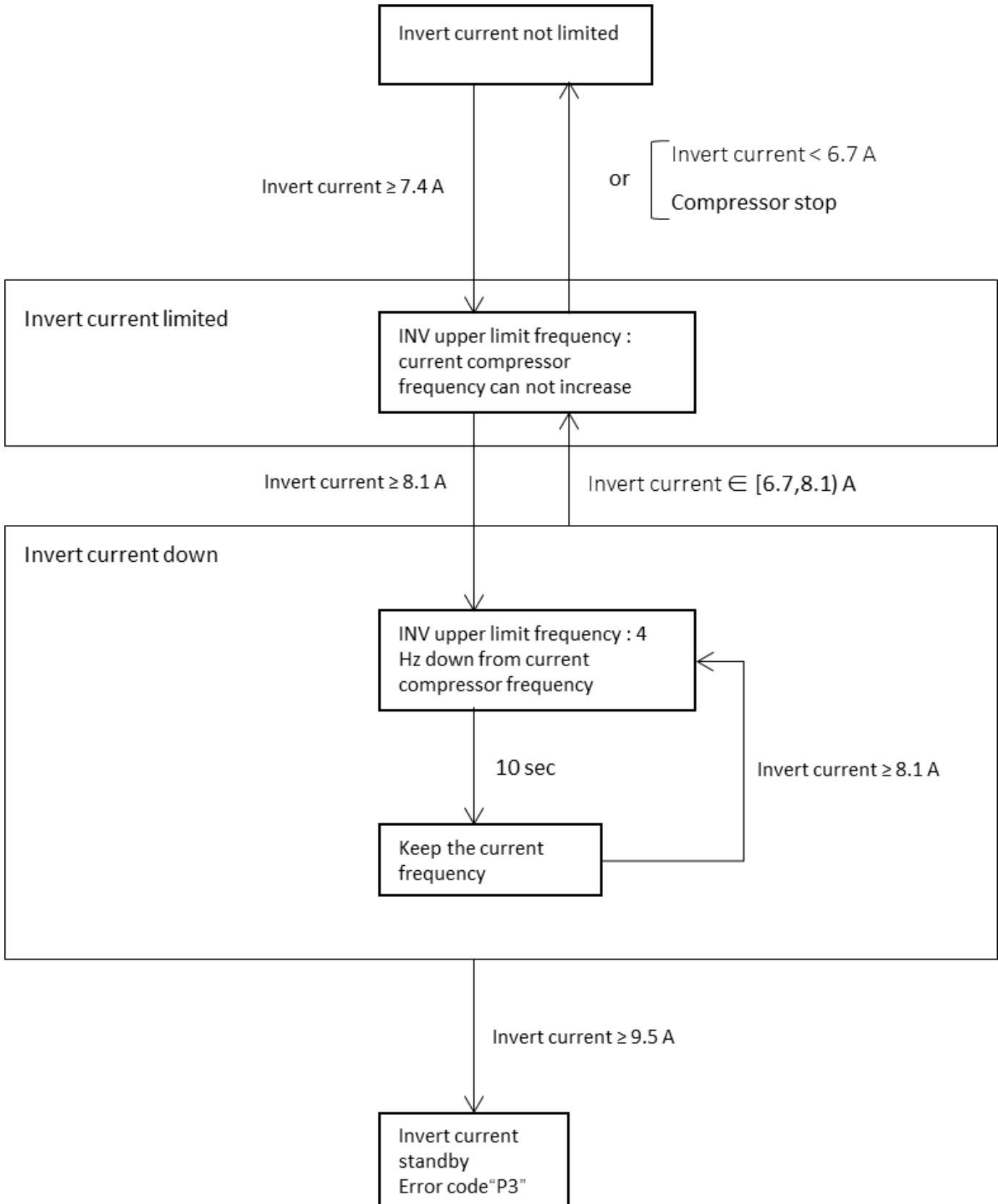

High Temperature Hydro Module



Inverter module temperature limits the frequency protection

Midea VR High Temperature Hydro Module

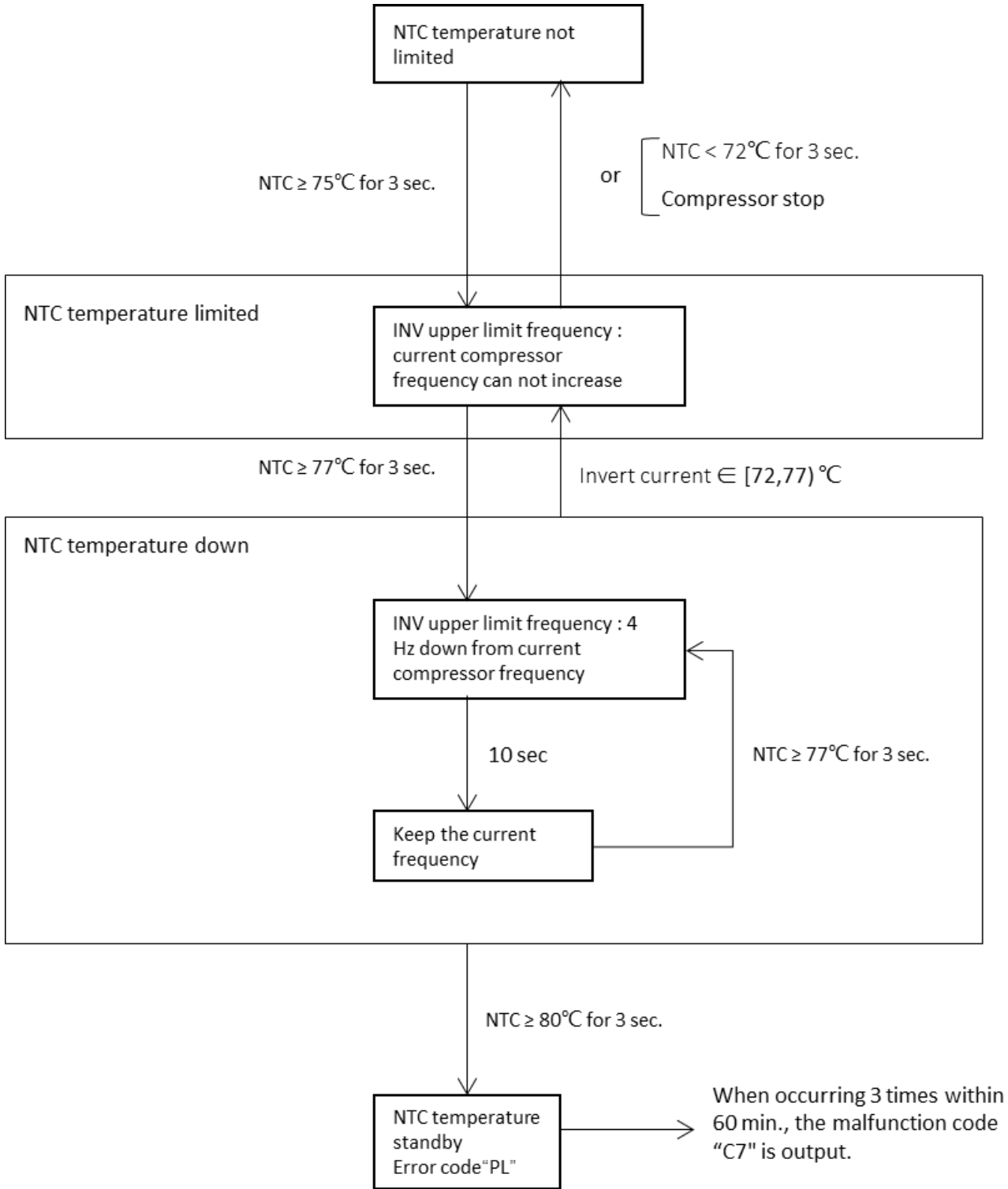

9 Appearance of the Wired Controller

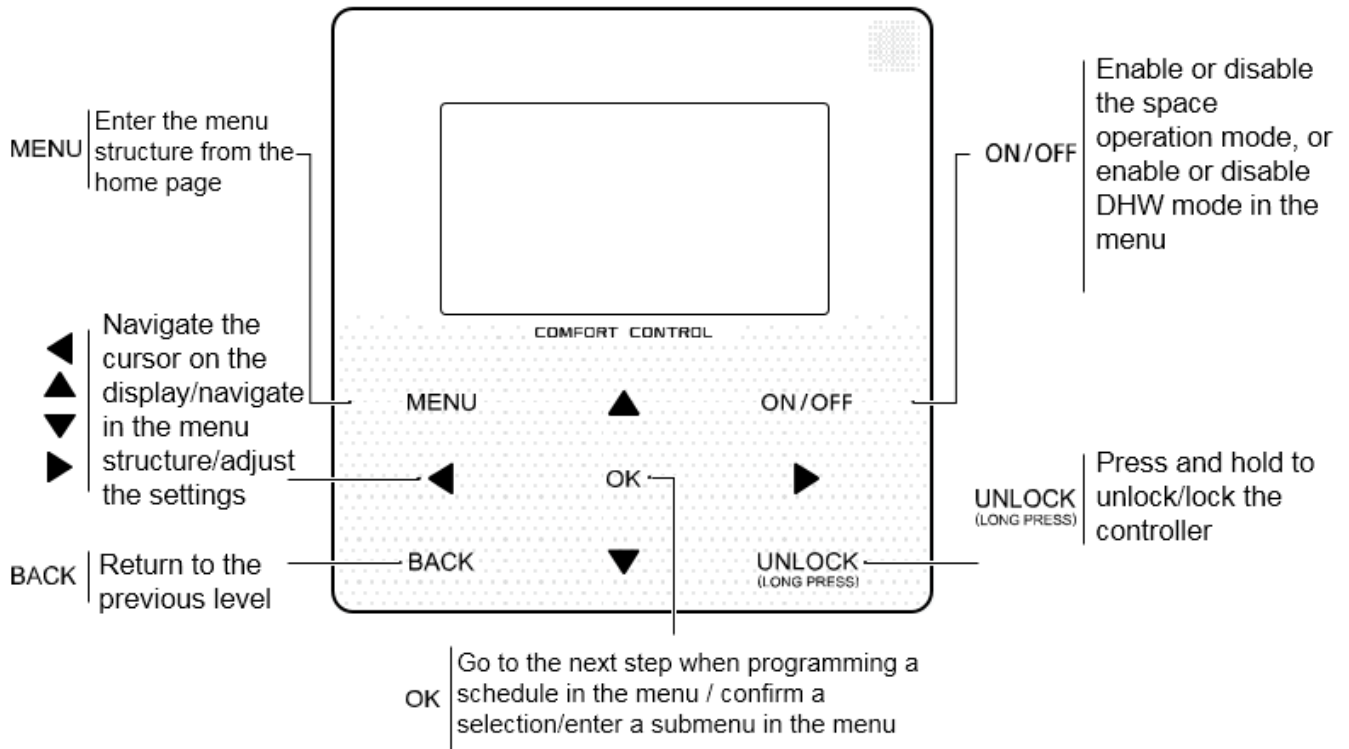

10 Status Icons

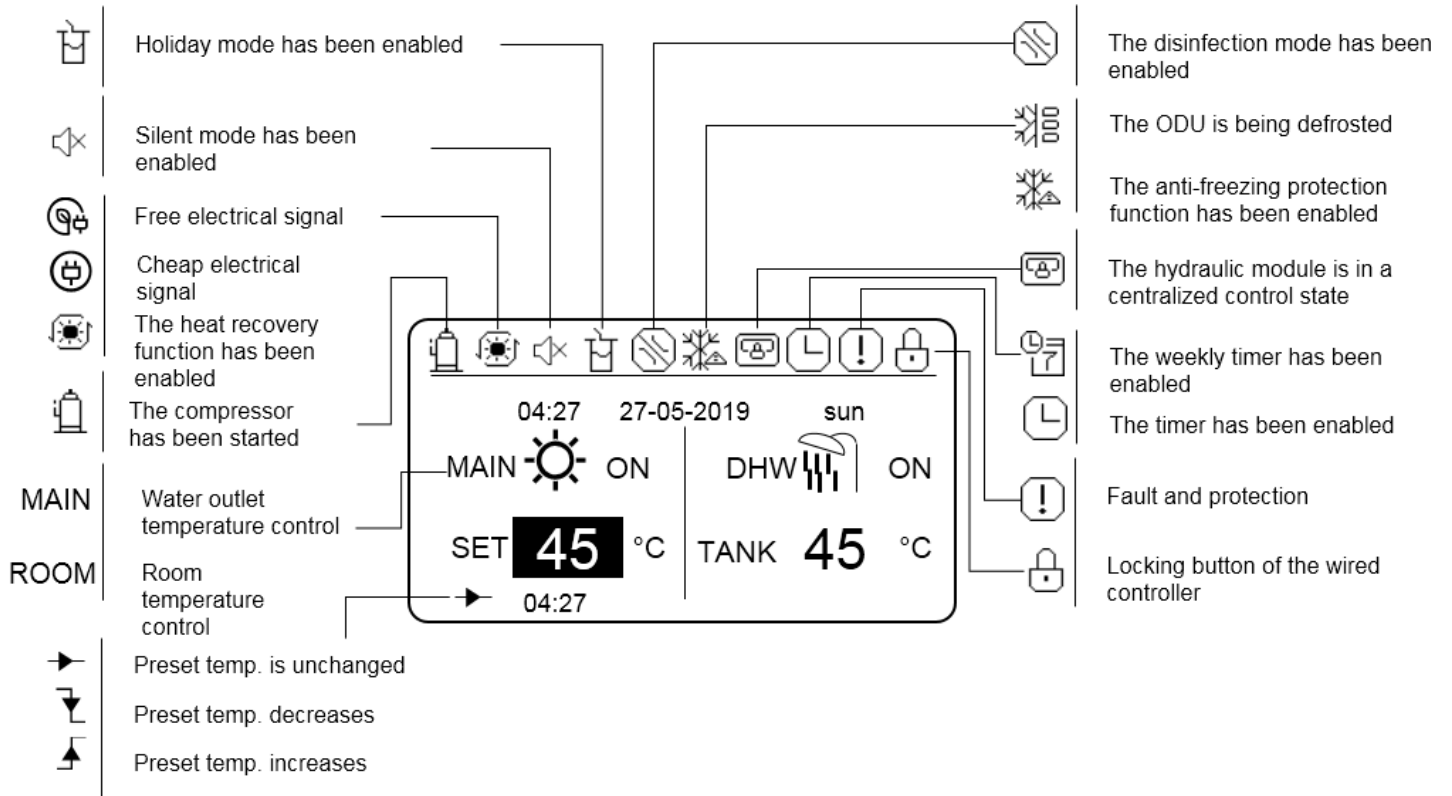

11 Using Home Pages

The hydraulic module features the heating function and water heating function, which can be classified into the hydraulic module that supports heat mode only ("FOR SERVICEMAN" > "Heat mode setting" > "HEAT MODE=YES" and "FOR SERVICEMAN" > "DHW mode setting" > "DHW MODE=NON"), the hydraulic module that supports DHW mode only (FOR SERVICEMAN" > "Heat mode setting" > "HEAT MODE=NON" and "FOR SERVICEMAN" > "DHW mode setting" > "DHW MODE=YES"), and the hydraulic module that supports both heat mode and DHW mode ("FOR SERVICEMAN" > "Heat mode setting" > "HEAT MODE=YES" and "FOR SERVICEMAN" > "DHW mode setting" > "DHW MODE=YES"). The heat mode is classified into water outlet temperature control ("FOR SERVICEMAN" > "Heat mode setting" > "LEAVING WATER TEMP.=YES") and room temperature control ("FOR SERVICEMAN" > "Heat mode setting" > "ROOM TEMP.=YES"). The water outlet temperature control and room temperature control is either-or. In water outlet temperature control mode, the hydraulic module sets the desired water outlet temperature and operates according to the defined desired temperature. In room temperature control mode, the hydraulic module sets the desired room temperature and conducts control according to the room temperature collected by the wired controller.

The wired controller interfaces are subject to on-site settings. Definitions of symbols of the wired controller:

ROOM---Room temperature control

MAIN---Water outlet temperature control

DHW--- Water heating mode

11.1 Scenario 1

Only heating mode is available and the hydraulic module is operating in water outlet temperature control mode. (For more information, please read the *Engineering Data Book*.)

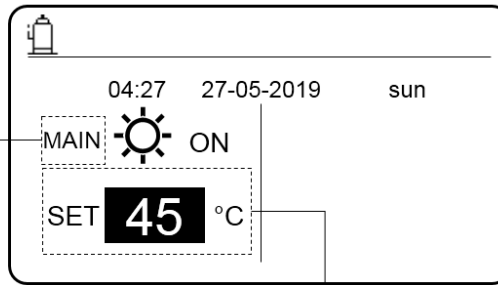
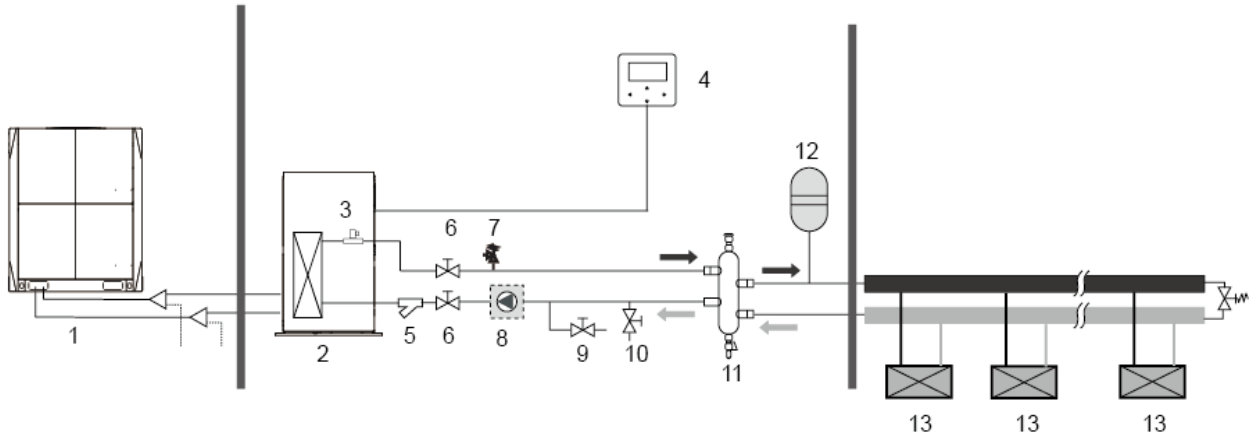

Indicates that the hydraulic module operates in water outlet temperature control mode.

Sets the desired water outlet temperature, ranging from 25°C to 80°C.

11.2 Scenario 2

Only heating mode is available and the hydraulic module operates in water outlet room control mode. (For more information, please read the *Engineering Data Book*.)

Note: The wired controller must be installed indoors, where heating is required. The wired controller is equipped with a temperature sensor for detecting room temperature.

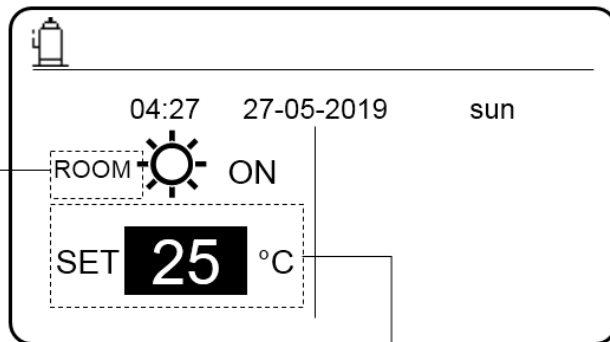
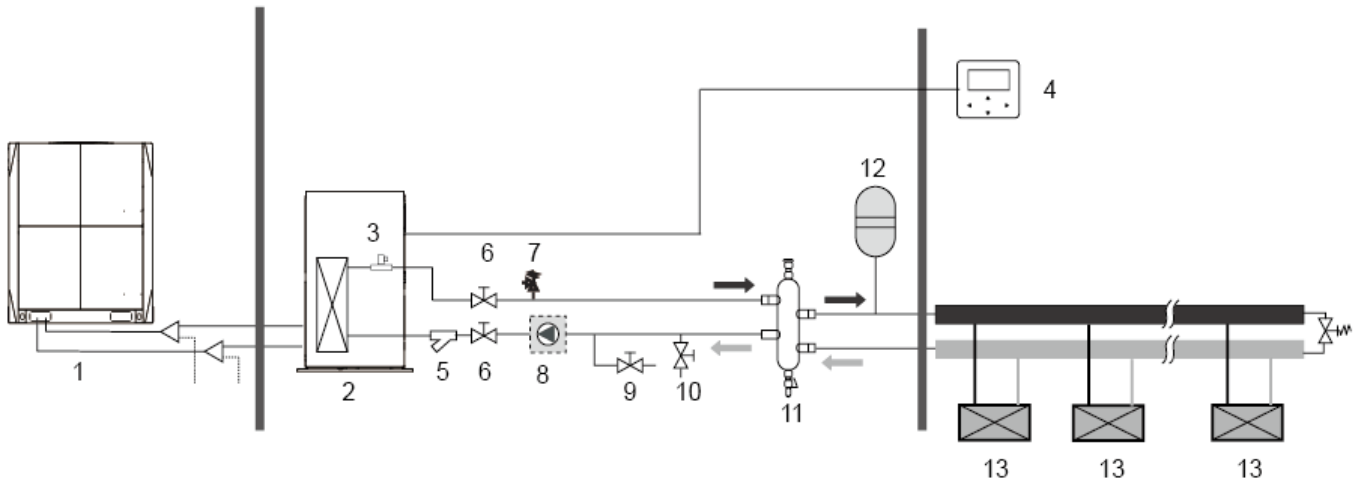

Indicates that the hydraulic module operates in room temperature control mode.

Sets the desired room temperature, ranging from 17°C to 30°C.

High Temperature Hydro Module



11.3 Scenario 3

Only heating mode is available. (For more information, please read the *Engineering Data Book*)

Midea VR High Temperature Hydro Module

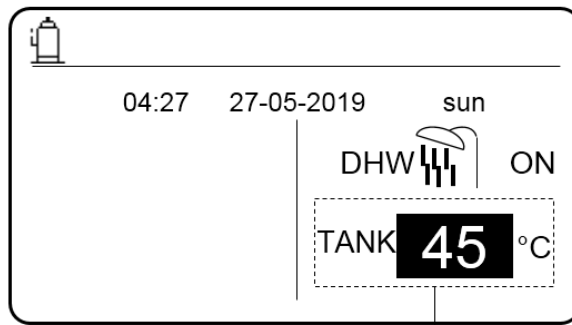
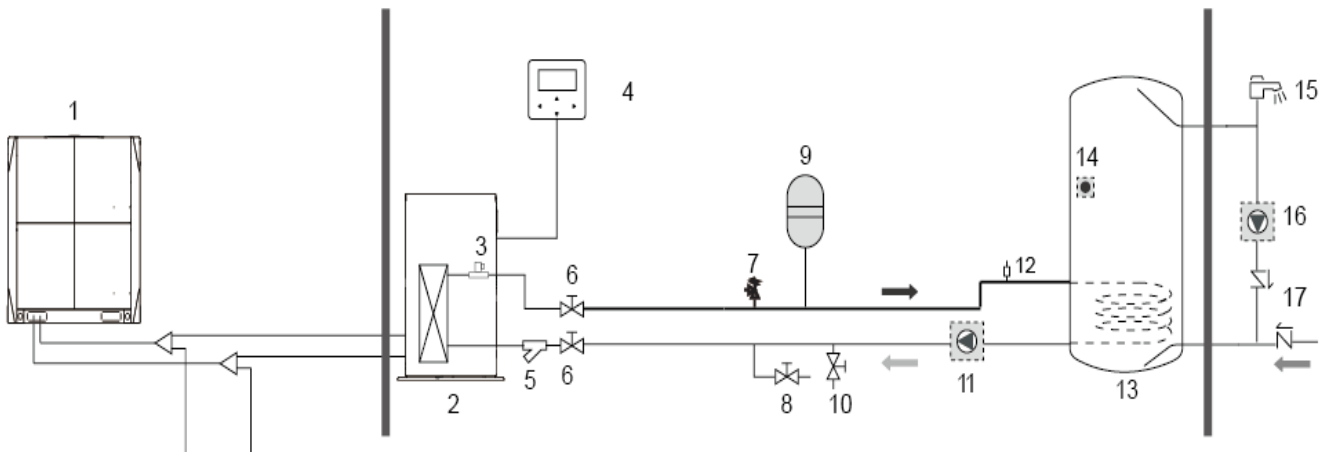

Sets the desired water tank temperature, ranging from 25°C to 80°C.

11.4 Scenario 4

Both heating mode and DHW mode are available. (For more information, please read the *Engineering Data Book*)

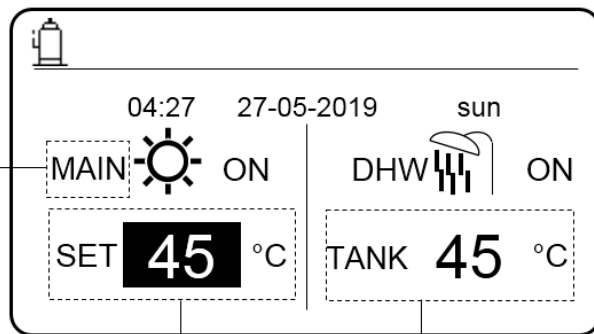
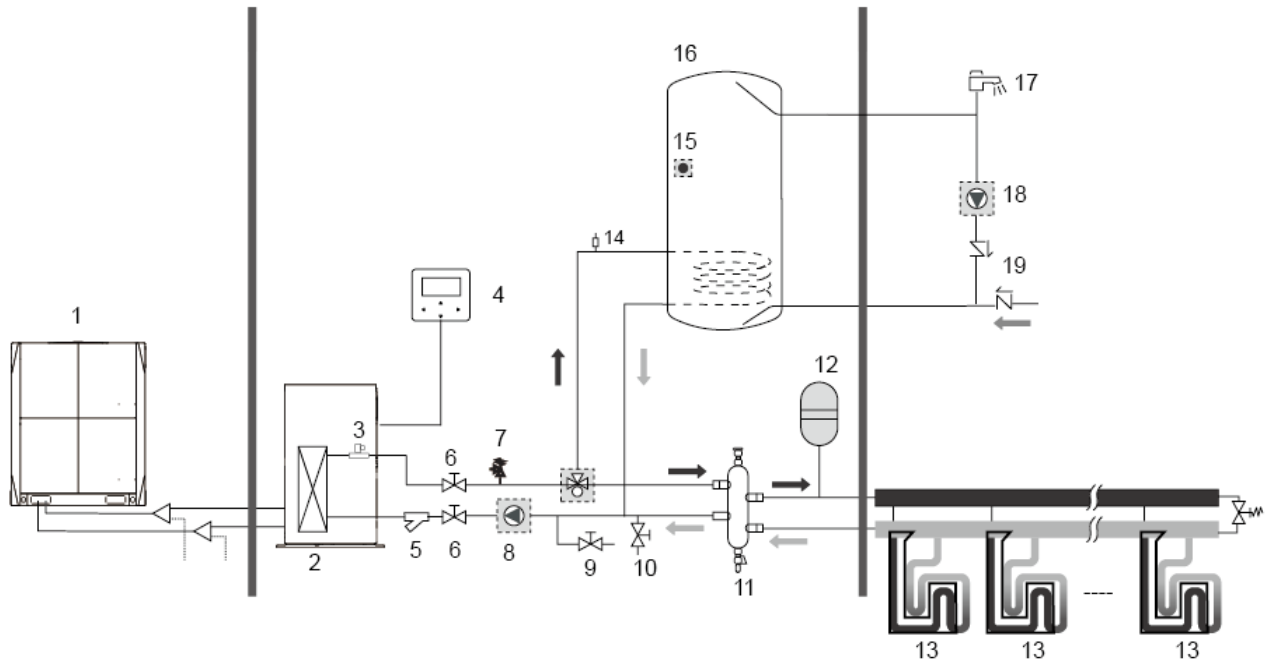

Indicates water outlet temperature control.

Sets the desired water outlet temperature, ranging from 25°C to 80°C.

Sets the desired water tank temperature, ranging from 25°C to 80°C.

High Temperature Hydro Module



11.5 Scenario 5

Only heating mode is available and there are multiple set points for the heating mode. (For more information, please read the *Engineering Data* and see "Multiple Set Points" on Page XX in this document.)

The settings of multiple set points do not affect the main interface. The temperature of multiple set points is set through the menu of the wired controller, while only the main room temperature is set on the main interface.

Note: The temperature of multiple set point 2 is lower than the temperature of multiple set point 1 and the temperature of multiple set point 1 is lower than the temperature set on the main interface.

Midea VR High Temperature Hydro Module

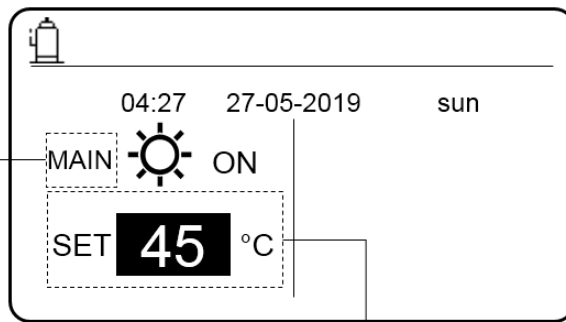
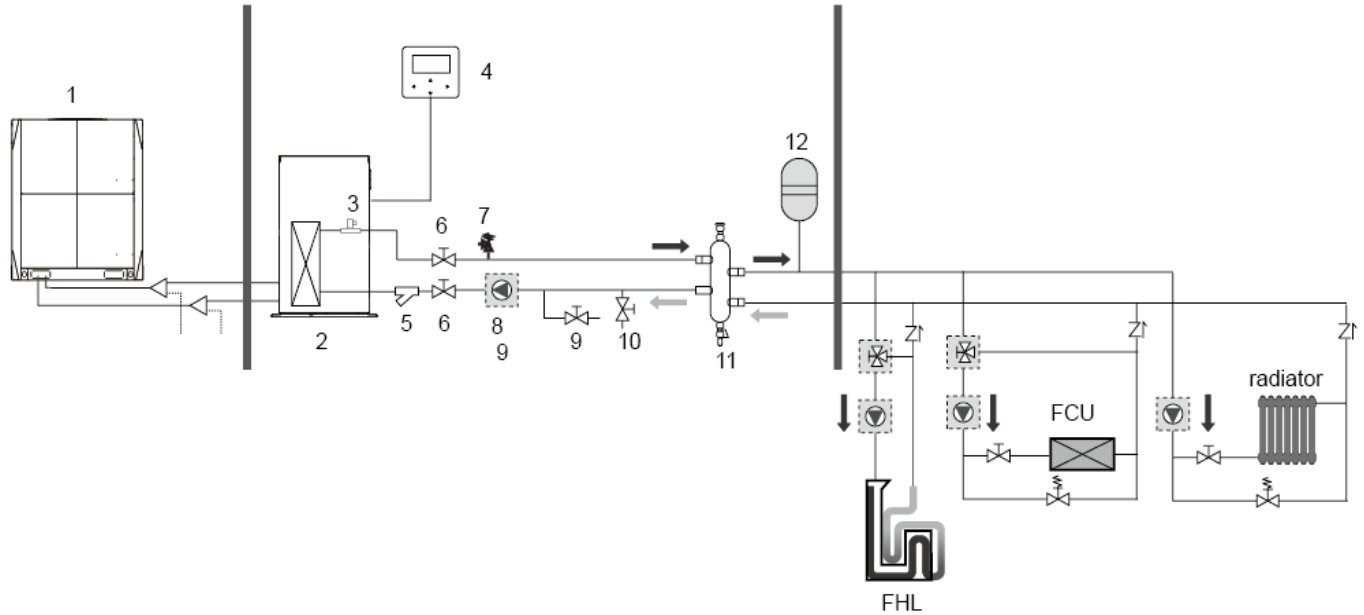

MAIN: Water outlet temperature control
ROOM: Room temperature control

Sets the desired temperature of the main set point.

11.6 Scenario 6

Group control of the hydraulic module.

When multiple hydraulic modules heat water in one water tank, the group control function of the hydraulic module should be used. (For more information, please read the *Engineering Data*.) The group control function is only valid for the DHW mode.

Notes:

1. The group control function of the hydraulic module is valid for the DHW mode only.
2. Master and slave hydraulic modules should be set. For instructions on how to set master and slave hydraulic modules, see the Engineering Data.
3. The master hydraulic module must be connected to a wired controller. The main wired controller can be used to set temperature.
4. The slave hydraulic module can be connected to or not connected to a wired controller. The secondary wired controller provides some functions, such as parameter query.
5. The circulating pump and water tank temperature sensor should be connected to the master hydraulic module.

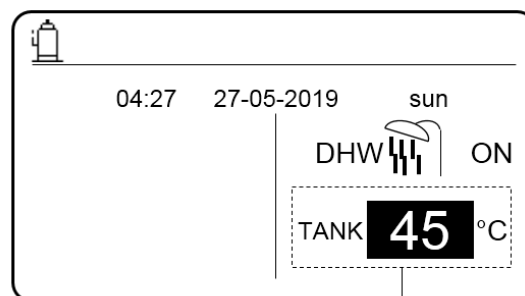
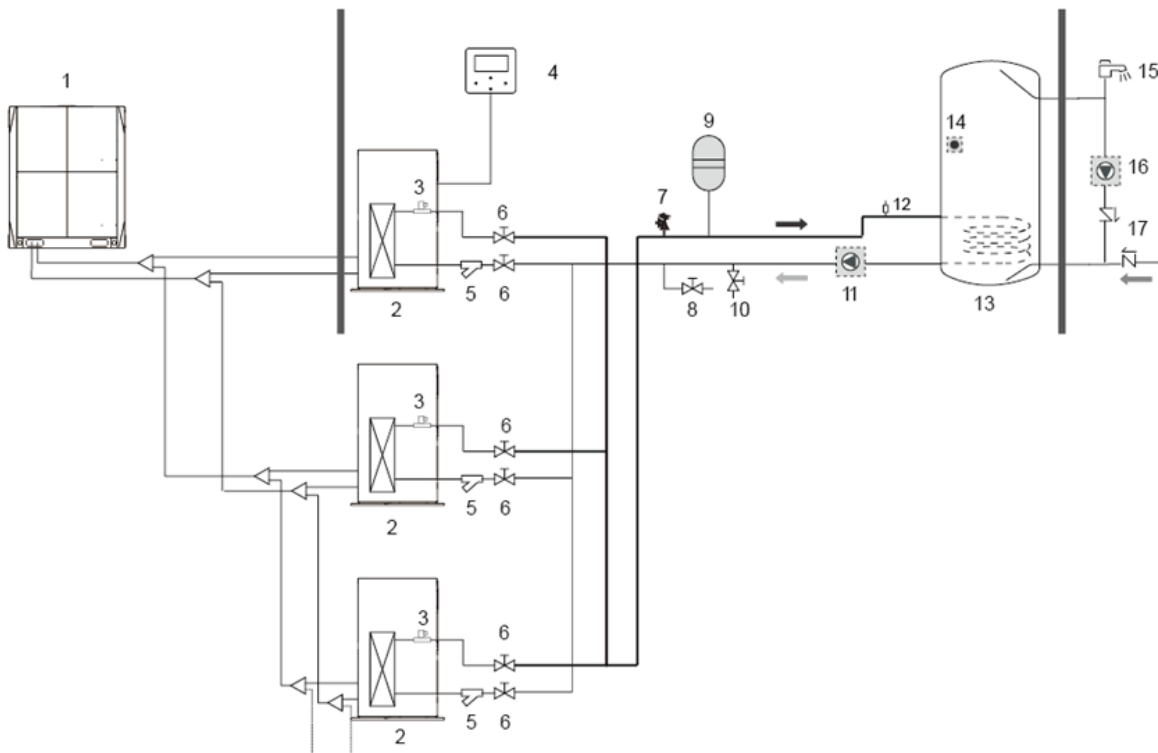

Sets the desired water tank temperature, ranging from 25°C to 80°C.

High Temperature Hydro Module

To enable the group control function, you need to set the DIP switch on the main board as follows: for the master hydraulic module, turn digit 11; for the slave hydraulic module, turn digit 10:

To enable the group control function, you need to set the DIP switch on the main board as follows: for the master hydraulic module, turn digit 11; for the slave hydraulic module, turn digit 10:





Notes for installers and service engineers

- The master unit must be connected to a wired controller. The wired controller is used to set the desired water tank temperature.
- The slave unit can be connected to or not connected to a wired controller. The wired controller of the slave unit provides the query function only.
- The pump is controlled by the master unit. The temperature sensor of the water tank is connected to the master unit.
- The wired controller connected to the master unit is used to set the desired water tank temperature.

12 Basic Application

12.1 Unlocking the screen

If the  icon is displayed on the screen, it indicates that the wired controller has been locked. If you press any key, the  icon blinks. Press and hold the **UNLOCK** key, the  icon will disappear. In this case, you can operate using the wired controller interface.

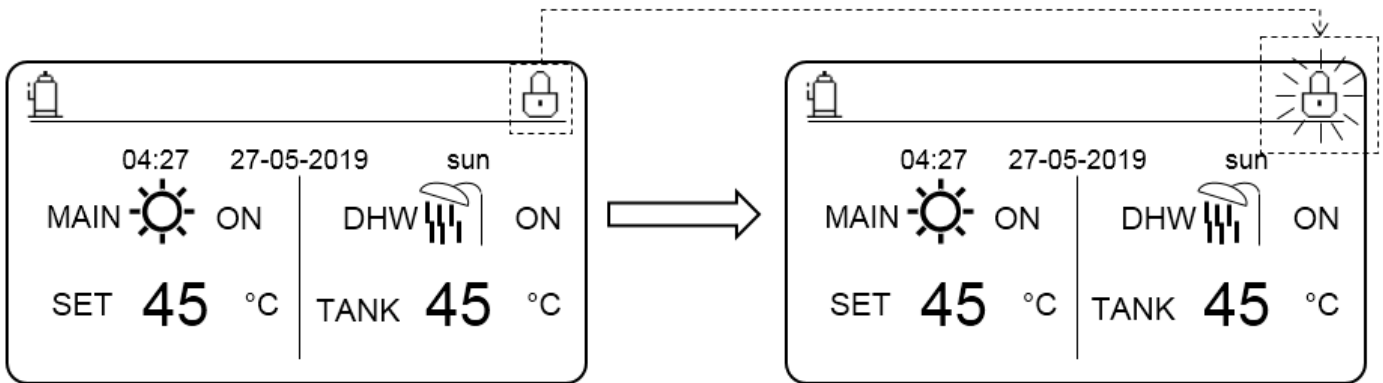

If you do not operate the wired controller for a long time (by default, 120s, which can be set on the wired controller. For details, see section 6.7 "Service Information".), the wired controller will lock automatically. If the wired controller is unlocked, press and hold the **UNLOCK** key, and the wired controller will be locked.

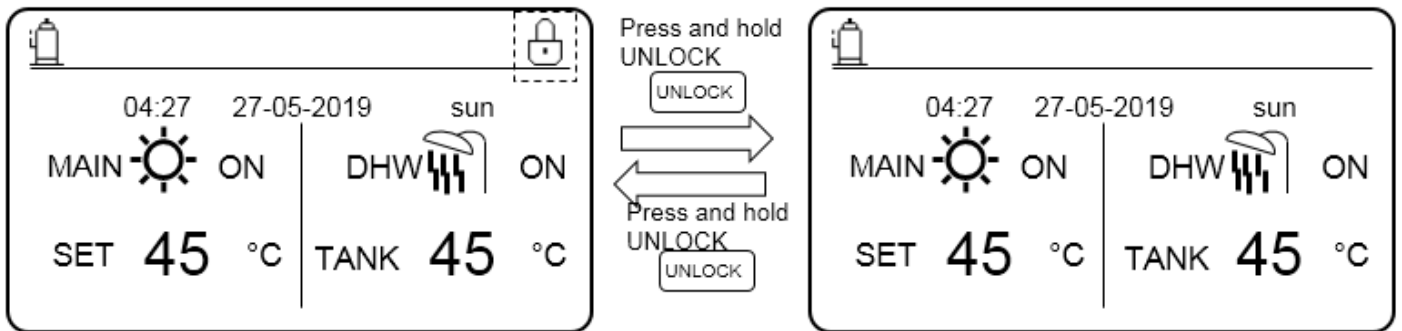

High Temperature Hydro Module

12.2 Enabling/Disabling Mode and Setting Temperature

Both heat mode and DHW mode can be enabled and disabled through the wired controller

12.2.1 Heat Mode

There are two control methods for the heat mode:

- Water outlet temperature control
- Room temperature control

Water outlet temperature control

In water outlet temperature control mode, the hydraulic module operates according to the defined water outlet temperature so that the water outlet temperature reaches the defined desired water outlet temperature. The water outlet temperature can be set manually, or through the timer function and weather temperature curve.

- Steps for setting the water outlet temperature control mode of the hydraulic module: **MENU > FOR SERVICEMAN > HEAT MODE > LEAVING WATER TEMP.**
- Set **LEAVING WATER TEMP.** to **YES**.
- The water outlet temperature ranges from 25°C to 80°C.
- Sets the mode to water outlet temperature control and heating main interface to MAIN.

Notes:

If **LEAVING WATER TEMP.** is set to **YES**, **ROOM TEMP.** is automatically set to **NON**. If **ROOM TEMP.** is set to **YES**, **LEAVING WATER TEMP.** is automatically set to **NON**

Notes:

If **LEAVING WATER TEMP.** is set to **YES**, **ROOM TEMP.** is automatically set to **NON**. If **ROOM TEMP.** is set to **YES**, **LEAVING WATER TEMP.** is automatically set to **NON**

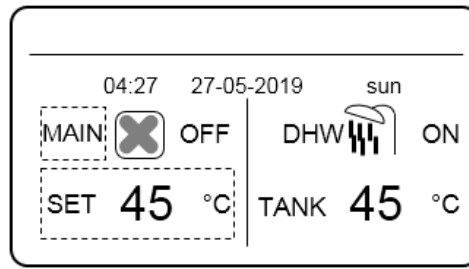

Press ▲ to choose heat mode.

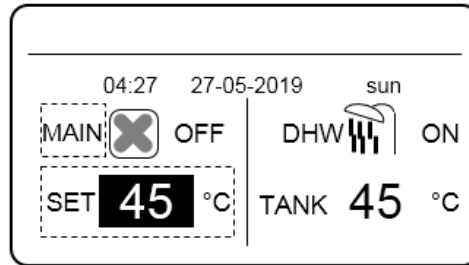
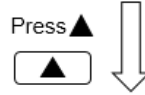

Press ▲ and ▼ to adjust desired temperature.

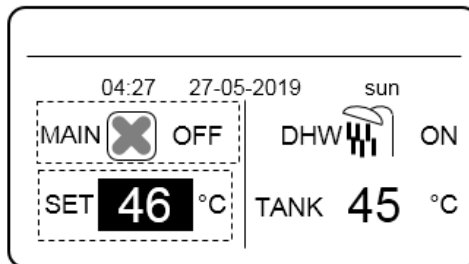

Press ON/OFF to turn on/off heat mode.

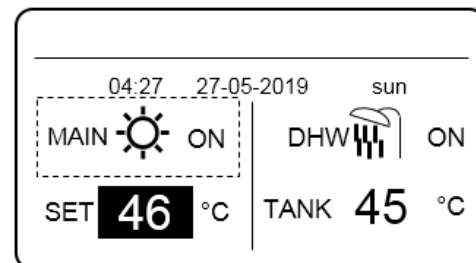

Room Temperature Control

In room temperature control mode, set the desired room temperature. The hydraulic module will control the operating of the hydraulic module according to the room temperature collected by the wired controller. The desired room temperature can be set manually, or through the timer function and weather temperature curve.

- Take the following steps to set room temperature control mode: **MENU > FOR SERVICEMAN > HEAT MODE > ROOM TEMP.**
- Set **ROOM TEMP.** to **YES**.
- Room temperature ranges from 17 C to 30 C.
- Sets the mode to water outlet temperature control and heating main interface to **ROOM**.

Notes:

1. The wired controller should be installed where heating is needed.
2. If **LEAVING WATER TEMP.** is set to **YES**, **ROOM TEMP.** is automatically set to **NON**. If **ROOM TEMP.** is set to **YES**, **LEAVING WATER TEMP.** is automatically set to **NON**.

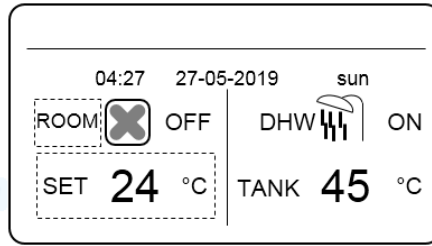

Press ▲ to choose heat mode.

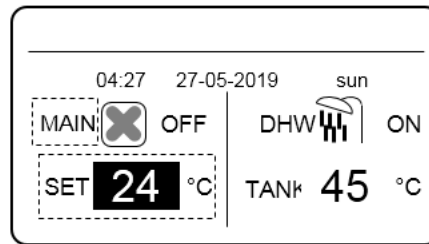
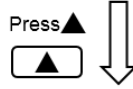

Press ▲ and ▼ to adjust desired temperature.

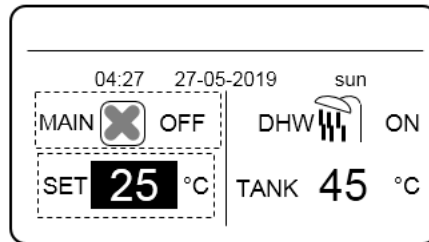

Press ON/OFF to turn on/off heat mode.

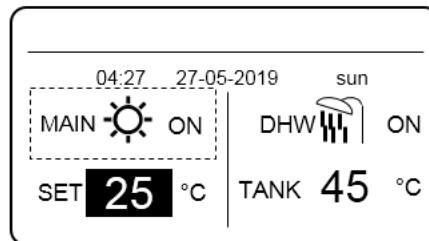

Assume that the temperature adjustment function in heat mode or mode on/off function are locked on the wired controller.

If you adjust temperature or enable/disable a mode, the following interface is displayed:

If you press **NO**, you will return to the main interface. If you press **YES**, you will enter the **CHILD LOCK** interface.

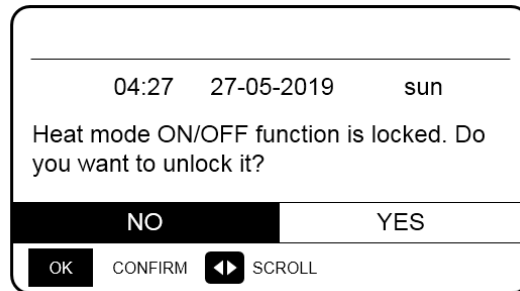
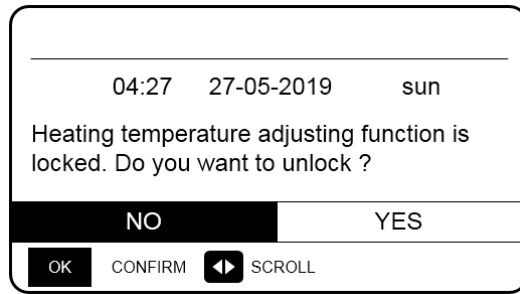

If temperature adjustment function or mode on/off function are locked on the centralized controller, the icon on the top will be lit. If you adjust temperature or enable/disable a mode on the wired controller, the following interface is displayed: In this case, the hydraulic module can be only unlocked on the centralized controller.

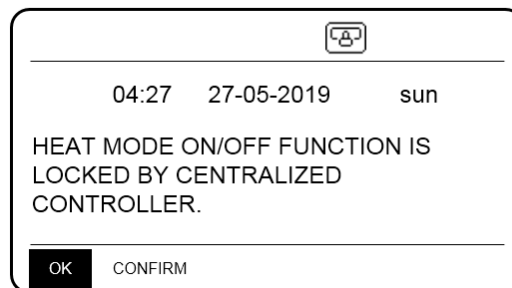
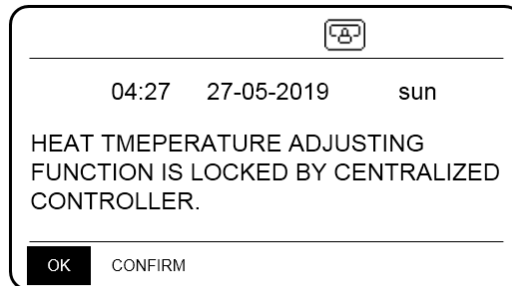

12.2.2 DHW Mode

- Take the following steps to set the DHW mode: **MENU > FOR SERVICEMAN > DHW MODE.**
- Set **DHW MODE** to **YES**.
- The water tank temperature ranges from 25°C to 80° C.

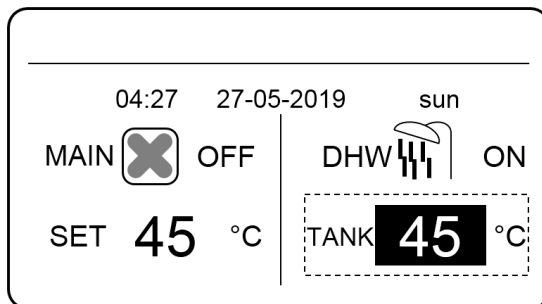

Press ▲ and ▼ to adjust desired temperature.

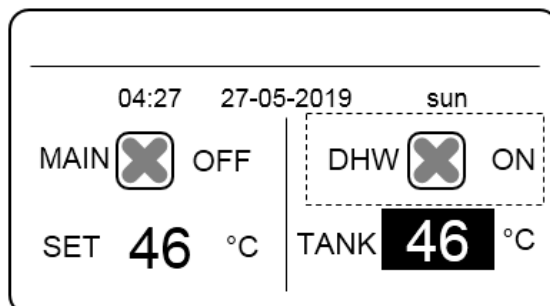
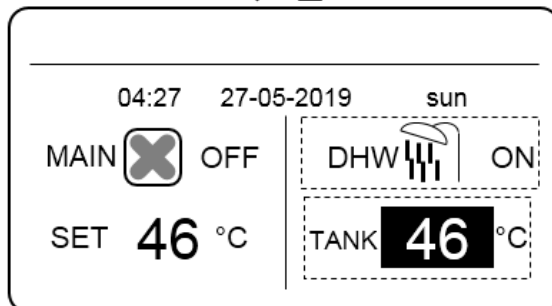

Press ON/OFF to turn on/off heat mode.

Assume that the temperature adjustment function in DHW mode or mode on/off function are locked on the wired controller. If you adjust temperature or enable/disable a mode, the following interface is displayed:

If you press **NO**, you will return to the main interface. If you press **YES**, you will enter the **CHILD LOCK** interface.

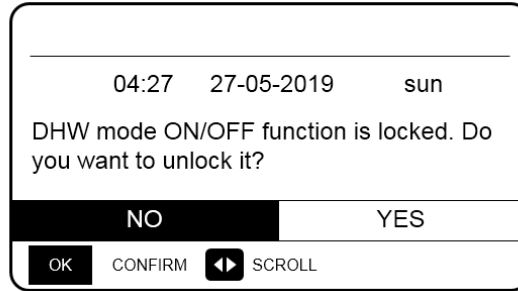
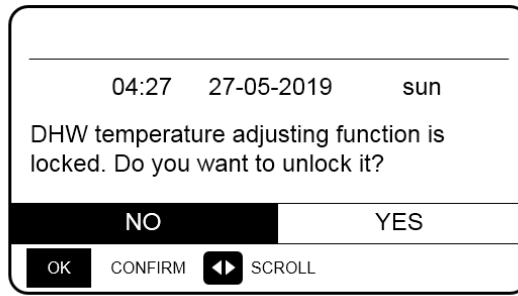

If temperature adjustment function or mode on/off function are locked on the centralized controller, the icon on the top will be lit. If you adjust temperature or enable/disable a mode on the wired controller, the following interface is displayed: In this case, the hydraulic module can be only unlocked on the centralized controller.

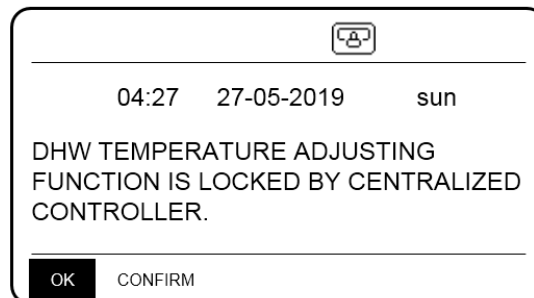
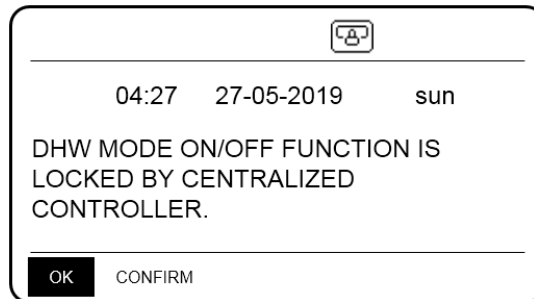

13 Functions

13.1 Heat Mode

In heat mode, PRESET TEMP.\WEATHER TEMP. SET\MULTIPLE SET POINT are available.

13.1.1 Pre-set Temperature

In heat mode, PRESET TEMP.\WEATHER TEMP. SET\MULTIPLE SET POINT are available.

- PRESET TEMP. =PRESET TEMPERATURE
- The PRESET TEMP. function will be automatically disabled in the following conditions:
 - 1) Timer is set.
 - 2) Weekly schedule is set.

Take the following steps to enable PRESET TEMP.: **MENU > PRESET TEMPERATURE > PRESET TEMP.** Press **OK**.

The following interface is displayed:

HEAT MODE			
PRESET TEMP.		WEATHER TEMP. SET	MULTIPLE SET POINT
No.		TIME	TEMP.
1	<input type="checkbox"/>	00:00	45°C
2	<input type="checkbox"/>	00:00	45°C
3	<input type="checkbox"/>	00:00	45°C

SCROLL 1/2

HEAT MODE			
PRESET TEMP.		WEATHER TEMP. SET	MULTIPLE SET POINT
No.		TIME	TEMP.
4	<input type="checkbox"/>	00:00	45°C
5	<input type="checkbox"/>	00:00	45°C
6	<input type="checkbox"/>	00:00	45°C

SCROLL 1/2

use "▲", "▼", "▶", "◀" to scroll and use "▲", "▼" to adjust the time and the temperature. When the cursor is on "■", as in the following page:

HEAT MODE			
PRESET TEMP.		WEATHER TEMP. SET	MULTIPLE SET POINT
No.		TIME	TEMP.
1	<input checked="" type="checkbox"/>	00:00	45°C
2	<input type="checkbox"/>	00:00	45°C
3	<input type="checkbox"/>	00:00	45°C

SELECT SCROLL 1/2

HEAT MODE			
PRESET TEMP.		WEATHER TEMP. SET	MULTIPLE SET POINT
No.		TIME	TEMP.
1	<input type="checkbox"/>	00:00	45°C
2	<input type="checkbox"/>	00:00	45°C
3	<input checked="" type="checkbox"/>	00:00	45°C

CANCEL SCROLL 1/2

Press "OK", and the "■" becomes "☑". The timer 1 is selected. Press "OK" again, and "☑" becomes "■". The timer 1 is unselected.

Use "▲", "▼", "▶", "◀" to scroll and use "▲", "▼" to adjust the time and the temperature. Six temperatures can be set.

High Temperature Hydro Module



For example:

The time is 8:00 and temperature is 60°C. If PRESET TEMP. is set as follows, the hydraulic module will operate according to the following curve.

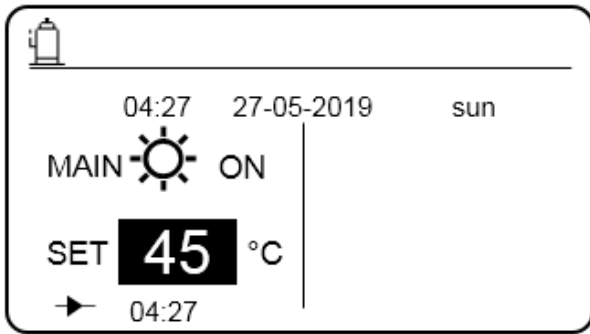

No.	TIME	TEMP.
1	8:00	70°C
2	12:00	60°C
3	15:00	70°C
4	18:00	60°C
5	20:00	70°C
6	23:00	60°C

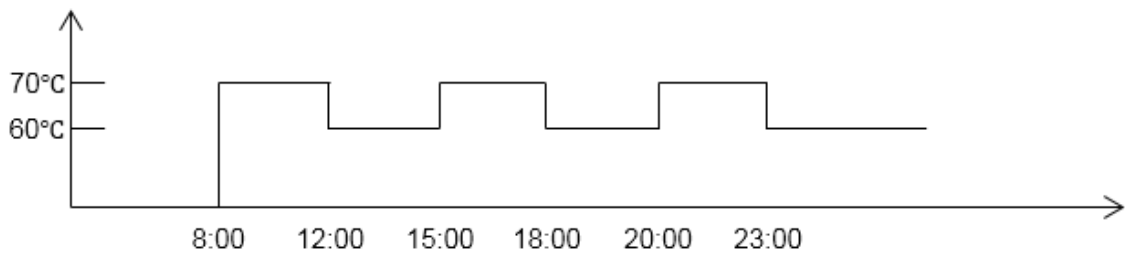

Notes for installers and service engineers

Important Notes

- When the multiple set point function is enabled, the PRESET TEMP. function is valid to space0 only.
- If the hydraulic module is powered off, the preset temperature at the current time is invalid. The hydraulic module will be started at the time point where the next preset temperature is set.
- When the timer function is valid, if you move the cursor to PRESET TEMP. and press the OK key, the following prompt is displayed:

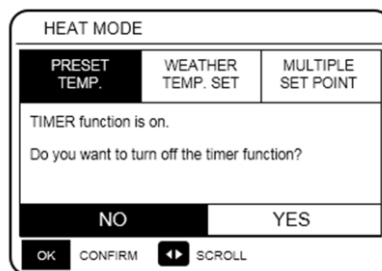

- The preset temperature is only valid for the water outlet temperature control of heat mode. If ROOM TEMP. is set to YES on the wired controller, the following information is displayed:

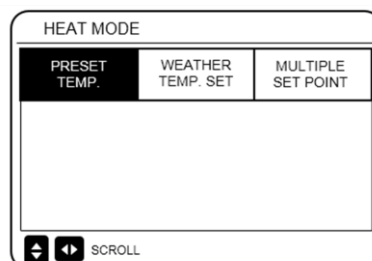

13.1.2 Weather Temperature Set

- WEATHER TEMP. SET=WEATHER TEMPERATURE
- On the **WEATHER TEMP.SET** page, you cannot set the desired water outlet temperature. The desired water outlet temperature is calculated according to the outside ambient temperature. The higher the outside ambient temperature, the lower the desired water temperature.
- During the operation of the weather temperature curve, you can set the shift value of the weather temperature curve with the range of [-5,+5]. The shift value is the difference between the calculation value and the actual operation value. Example: +5°C indicates that the actual operation value is 5°C greater than the calculation value.
- Take the following steps to set the weather temperature curve: **MENU > PRESET TEMPERATURE > WEATHER TEMP. SET**. Press **OK**. The following interface is displayed:

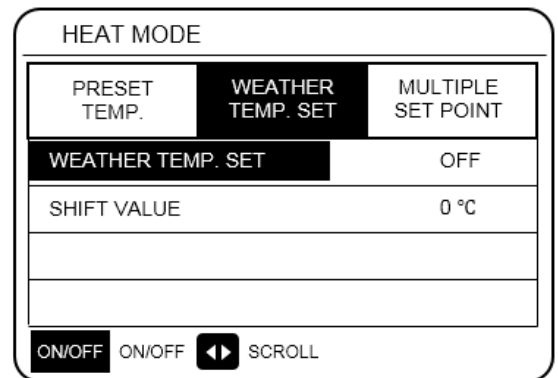
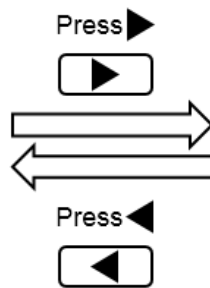
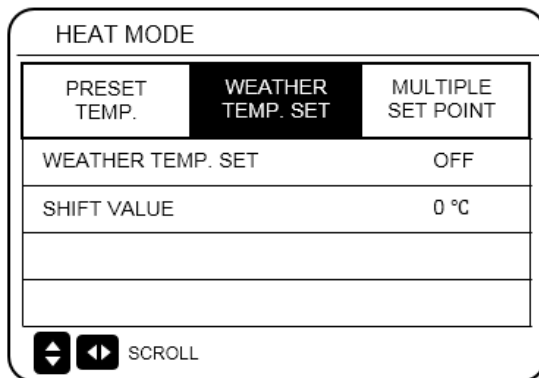

Press ON/OFF button to turn on/off weather temperature function.

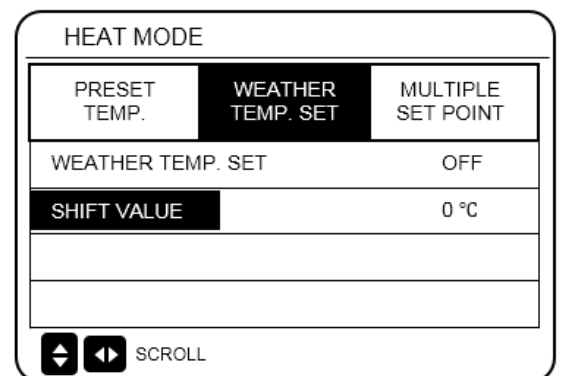
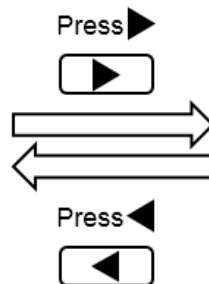
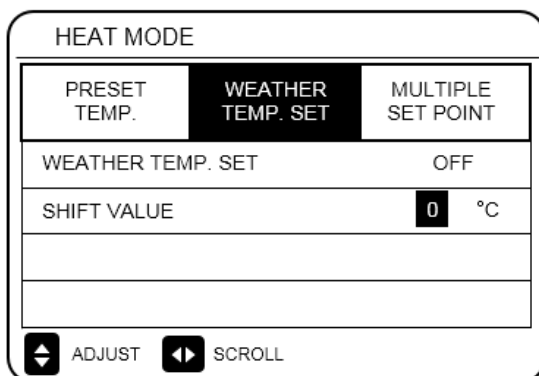
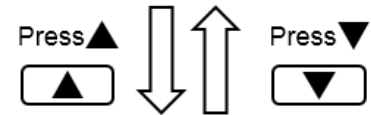

Press "▲" or "▼" to adjust the shift value.

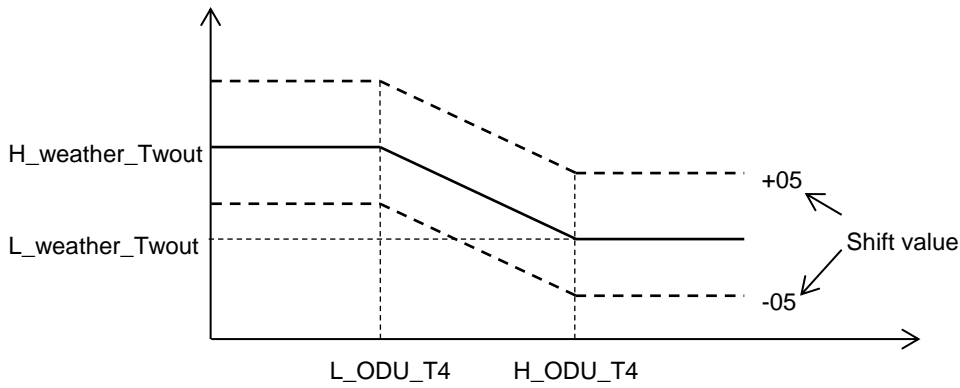

H_ODU_T4: high outdoor temperature (indicates the high temperature point among outdoor ambient temperature)

L_ODU_T4: low outdoor temperature (indicates the low temperature point among outdoor ambient temperature)

L_weather_Twout: the desired leaving water temperature when the outdoor temperature equals or drops below the low ambient temperature (indicates that the desired water outlet temperature is lower than the low temperature point of the outdoor ambient temperature)

H_weather_Twout: the desired leaving water temperature when the outdoor temperature equals or rises above the high ambient temperature (indicates the desired water outlet temperature is higher than the high temperature point of the outside ambient temperature)

If Weather TEMP.SET is enabled, you cannot set the desired water outlet temperature. If you press ▼ or ▲, the following interface is displayed.

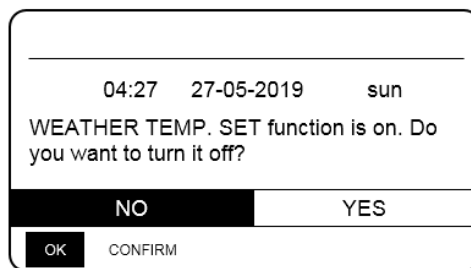

Press **OK** at **NO** to return to the main interface. Move the cursor to **YES**, and then press **OK**. The weather temperature curve setting interface is displayed as follows.

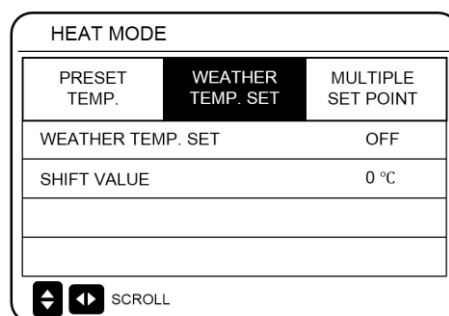

13.1.3 Multiple Set Point Function

When the hydraulic module is connected to multiple terminals that raise different water temperature requirements, you need to use the multiple set point function. The multiple set point function is used to set the desired water outlet temperature of space1 and space2. (For more information, please read the *Engineering Data*.)

The hydraulic module will calculate the space that requires energy and operate at the highest water temperature among the water outlet temperature requirements.

Note: For space0, water temperature is set on the main interface.

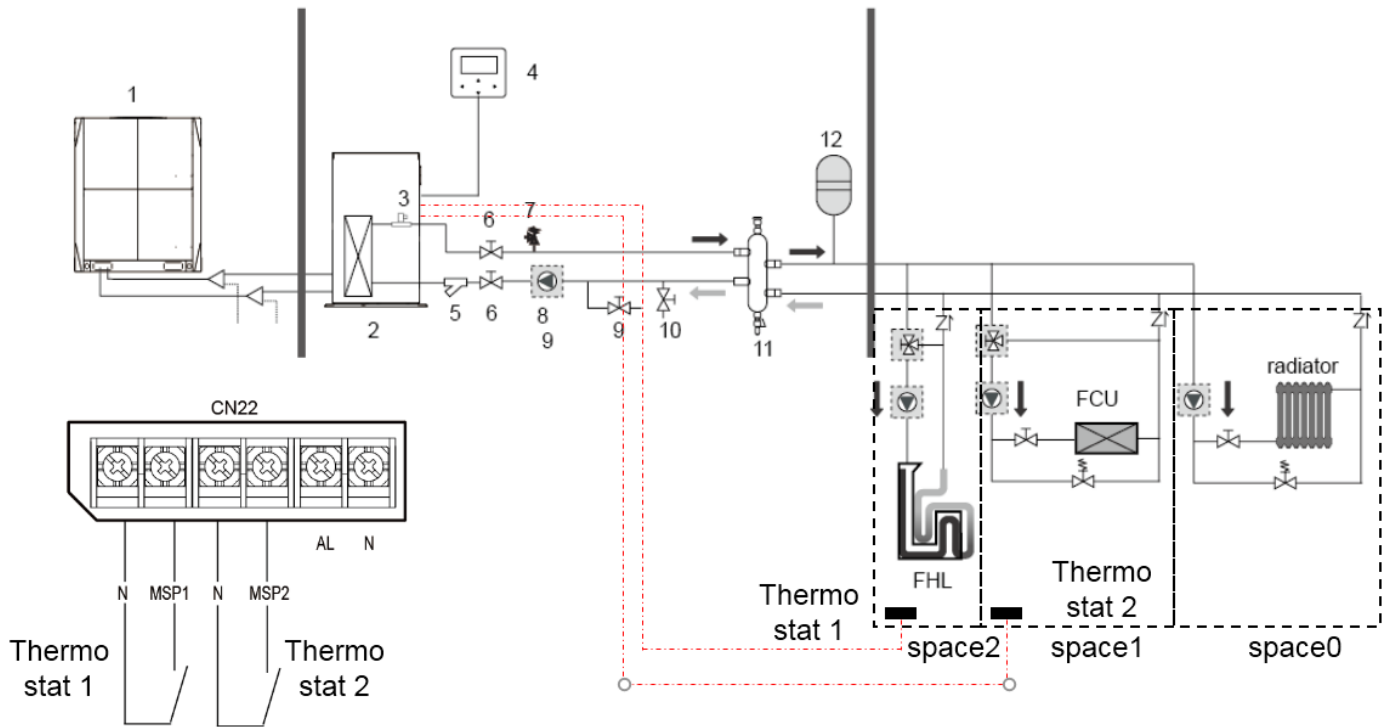

- Notes:
1. The hydraulic module can meet the control requirements at different water temperatures. You must connect an external third-party temperature reduction device to the circuits of space1 and space2.
 2. The multiple set point switch can be set on the FOR SERVICEMAN interface of the wired controller. If multiple set point 1=YES or multiple set point 2=YES, this indicates that multiple set points exist.
 3. On the wired controller, multiple set point 1 required temp. is corresponding to the required water temperature of multiple set point 1, while multiple set point 2 required temp. is corresponding to the required water temperature of multiple set point 2.
 4. The energy demand of space1 is determined according to the level signal of the external thermostat 1 of the main control board. If the level is low, it indicates that there is an energy demand, while if the level is high, it indicates that energy is not demanded.
 5. Energy demand of space2 is determined according to the level signal of the external thermostat 2 of the main control board. If the level is low, it indicates that there is an energy demand, while if the level is high, it indicates that energy is not demanded.

HEAT MODE		
PRESET TEMP.	WEATHER TEMP. SET	MULTIPLE SET POINT
SPACE 1 DESIRED TEMP.		45 °C
SPACE 2 DESIRED TEMP.		30 °C

SCROLL

No.	Desired temperature	Thermo status (energy demand status)			
		OFF	ON	OFF	OFF
space 0	a	OFF	ON	OFF	OFF
space 1	b	OFF	ON/OFF	ON	OFF
space 2	c	OFF	ON/OFF	ON/OFF	ON
Resulting desired temp.		OFF	a	b	c

13.2 Domestic Hot Water

DOMESTIC HOT WATER (DHW) has DISINFECT/DHW PUMP 2 items.

13.2.1 Disinfection Mode

In disinfection mode, legionella bacteria can be killed. In disinfection mode, the water tank temperature will forcedly rise to 70°C to 80°C. The disinfection temperature can be set on the FOR SERVICEMAN interface

Choose **MENU > DOMESTIC HOT WATER > DISINFECT**. Press **OK**. The following interface is displayed.

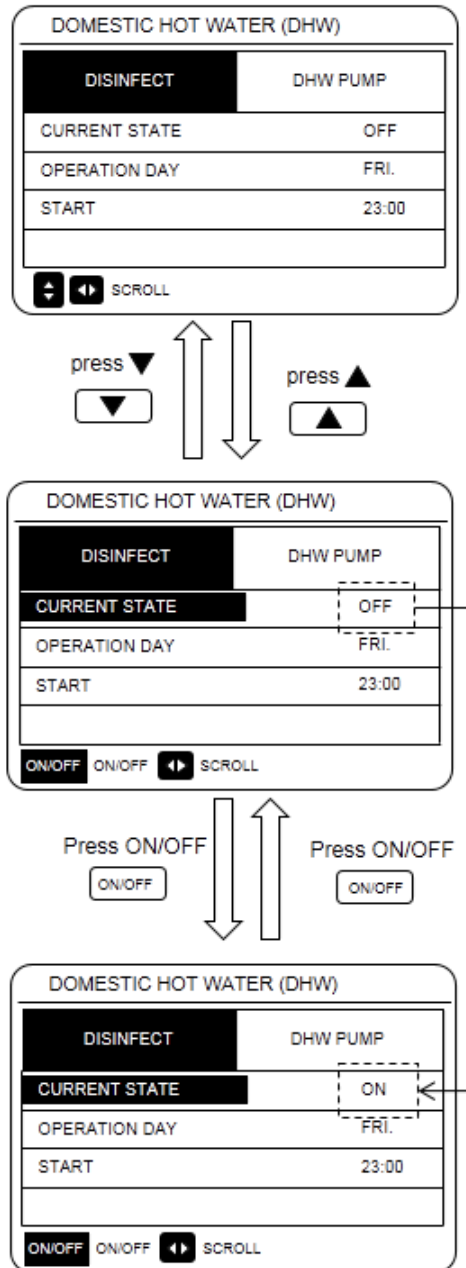

High Temperature Hydro Module



Use "◀", "▶", "▼", "▲" to scroll and use "▼", "▲" to adjust the parameters when setting "OPERATE DAY" and "START". If the OPERATE DAY is set to FRIDAY and the START is set 23:00, the disinfect function will activate at 23:00 on Friday. If the disinfect function is running, the following page will appear

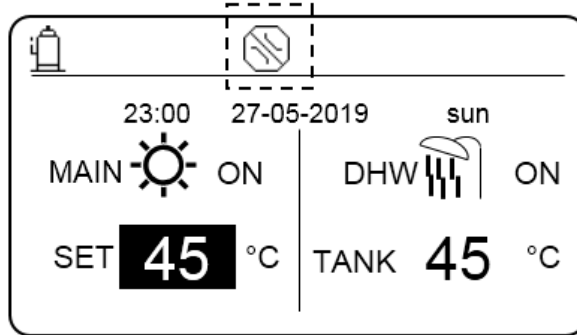

Note:

When the hydraulic module operates in disinfection mode, if you press the **On/Off** key, the pressing is invalid and the following interface is displayed.

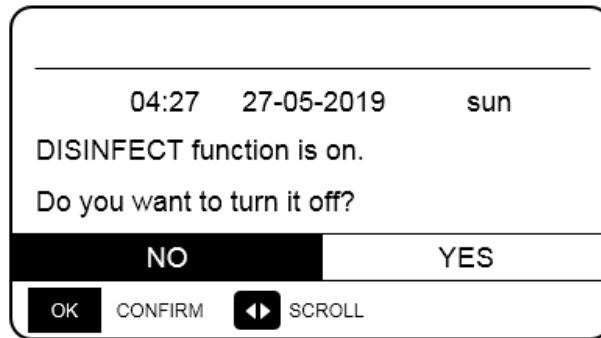

In disinfection mode, the hydraulic module will operate according to the following figure. The water temperature of the water tank will keep the disinfection temperature $T_{\text{tank_DI}}$.

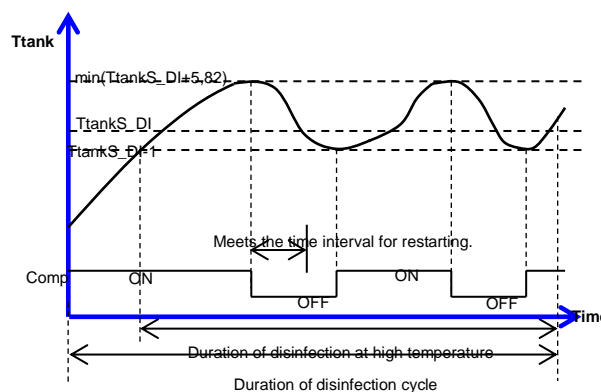

13.2.2 DHW Pump

The DHW PUMP function is used to control the start time of the water tank and pump so that hot water can flow out of the tap at any time.

Choose **MENU > DOMESTIC HOT WATER > DHW PUMP**. Press **OK**. The following interface is displayed.

DOMESTIC HOT WATER (DHW)

DISINFECT		DHW PUMP	
No.	TIME	No.	TIME
1	<input type="checkbox"/> 00:00	4	<input type="checkbox"/> 00:00
2	<input type="checkbox"/> 00:00	5	<input type="checkbox"/> 00:00
3	<input type="checkbox"/> 00:00	6	<input type="checkbox"/> 00:00

⏪ ⏩ SCROLL
1/2

DOMESTIC HOT WATER (DHW)

DISINFECT		DHW PUMP	
No.	TIME	No.	TIME
7	<input type="checkbox"/> 00:00	10	<input type="checkbox"/> 00:00
8	<input type="checkbox"/> 00:00	11	<input type="checkbox"/> 00:00
9	<input type="checkbox"/> 00:00	12	<input type="checkbox"/> 00:00

⏪ ⏩ SCROLL
2/2

Move to "■", press "OK" to select or unselect. (the timer is selected. the timer is unselected.)

DOMESTIC HOT WATER (DHW)

DISINFECT		DHW PUMP	
No.	TIME	No.	TIME
1	<input checked="" type="checkbox"/> 00:00	4	<input type="checkbox"/> 00:00
2	<input type="checkbox"/> 00:00	5	<input type="checkbox"/> 00:00
3	<input type="checkbox"/> 00:00	6	<input type="checkbox"/> 00:00

⏪ ⏩ SCROLL
1/2

Use "◀", "▶", "▼", "▲" to scroll and use "▼", "▲" to adjust the parameters.

Use "◀", "▶", "▼", "▲" to scroll and use "▼", "▲" to adjust the parameters.

High Temperature Hydro Module



For example: You have set the parameter about the DHW PUMP (See "FOR SERVICEMAN" > "DHW MODE SETTING" on "Engineering Data"). PUMP RUNNING TIME is 30 minutes.

Set as follows:

No.	START
1	06:00
2	07:00
3	8:00
4	09:00



Notes for installers and service engineers

Important Notes

- If DHW MODE=NON, choose MENU > DOMESTIC HOT WATER. Press OK. The following interface is displayed.

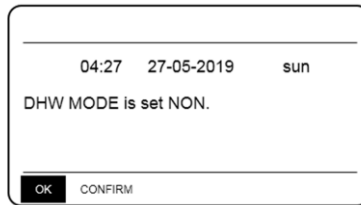

- If DISINFECT MODE=NON on the FOR SERVICEMAN interface, choose MENU > DOMESTIC HOT WATER > DOMESTIC HOT WATER. Press OK. The following interface is displayed.
- If DISINFECT MODE=NON on the FOR SERVICEMAN interface, choose MENU > DOMESTIC HOT WATER > DOMESTIC HOT WATER. Press OK. The following interface is displayed.

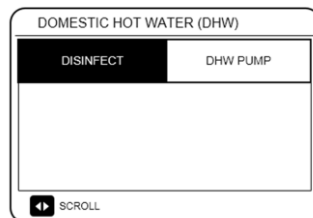

- If DHW PUMP RUNNING TIME=NON, choose MENU > DOMESTIC HOT WATER > DHW PUMP. Press OK. The following interface is displayed.

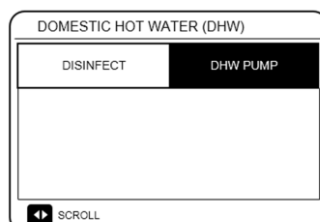

13.3 Schedule Function

The **SCHEDULE** menu contains the following items:

- 1) TIMER
- 2) WEEKLY SCHEDULE
- 3) SCHEDULE CHECK
- 4) CANCEL TIMER

13.3.1 TIMER Function

If the timer function is enabled, the icon will be displayed on the main interface of the wired controller. If the weekly schedule function is enabled, the timer function will be disabled.

SCHEDULE					
TIMER	WEEKLY SCHEDULE	SCHEDULE CHECK	CANCEL TIMER		
No.	START	END	MODE	TEMP.	
1	<input type="checkbox"/>	00:00	00:00	HEAT	45°C
2	<input type="checkbox"/>	00:00	00:00	HEAT	45°C
3	<input type="checkbox"/>	00:00	00:00	HEAT	45°C

SCROLL

SCHEDULE					
TIMER	WEEKLY SCHEDULE	SCHEDULE CHECK	CANCEL TIMER		
No.	START	END	MODE	TEMP.	
4	<input type="checkbox"/>	00:00	00:00	HEAT	45°C
5	<input type="checkbox"/>	00:00	00:00	HEAT	45°C
6	<input type="checkbox"/>	00:00	00:00	HEAT	45°C

SCROLL

Use "◀", "▶", "▼", "▲" to scroll and use "▼", "▲" to adjust the time, the mode and the temperature. Move to "■", press "OK" to select or unselect.

(the timer is selected. the timer is unselected.) six timers can be set.

If you want to cancel the TIMER, change the cursor to " ", and press "OK". The will become , and the timer is disabled.

If the start time is later than the end time, the following interface is displayed.

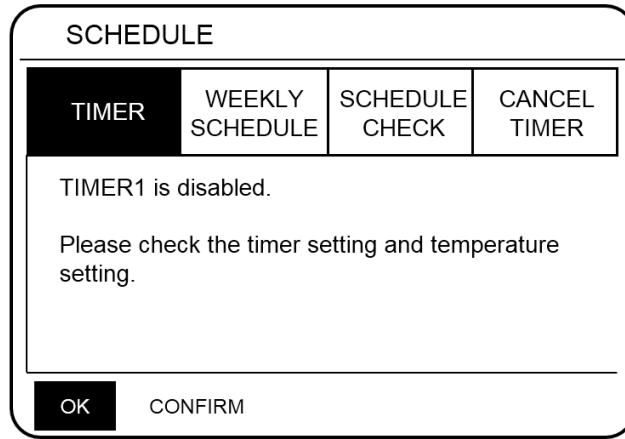

For example:

Six groups of schedules are set, as shown in the following table:

No.	START	END	MODE	TEMP.
1	01:00	03:00	DHW	70
2	07:00	09:00	HEAT	50
3	11:30	13:00	DHW	70
4	14:00	16:00	HEAT	50
5	15:00	19:00	DHW	70
6	18:00	23:30	HEAT	50

The hydraulic module will operate as shown in the following figure:

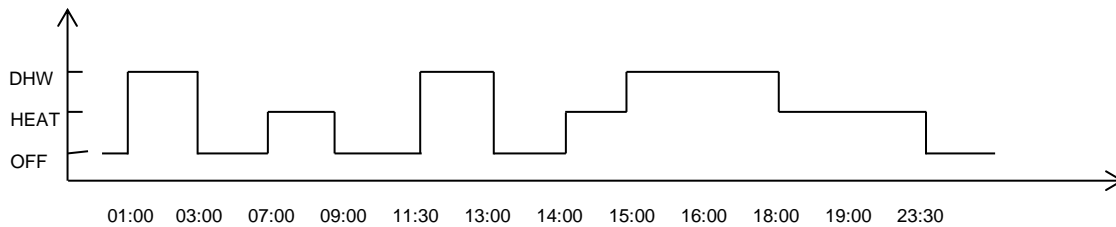

TIME	The operation of the controller
01:00	DHW mode is turned ON
03:00	DHW mode is turned OFF
07:00	HEAT MODE is turned ON
09:00	HEAT MODE is turned OFF
11:30	DHW MODE is turned ON
13:00	DHW MODE is turned OFF
14:00	HEAT MODE is turned ON
15:00	DHW MODE is turned ON and HEAT MODE is turned OFF
18:00	HEAT MODE is turned ON and DHW MODE is turned OFF
23:30	HEAT mode is turned OFF

Notes for installers and service engineers

Caution

If the start time is the same as the end time, the schedule is invalid.

13.3.2 Weekly Schedule

Timer and weekly schedule cannot take effect at the same time. The time which is set later will take effect first. If the weekly schedule is set, the icon will be displayed on the main interface.

Choose **MENU > SCHEDULE > WEEKLY SCHEDULE** . Press **OK**. The following interface is displayed.

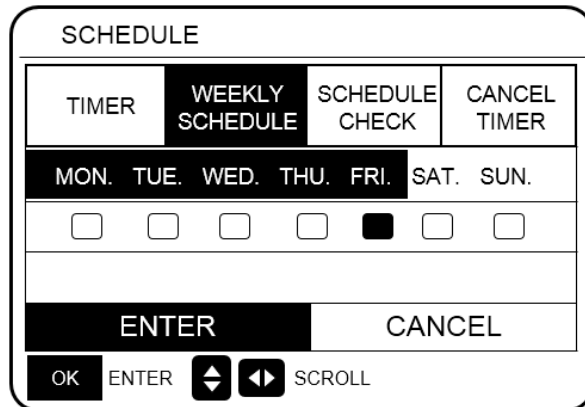
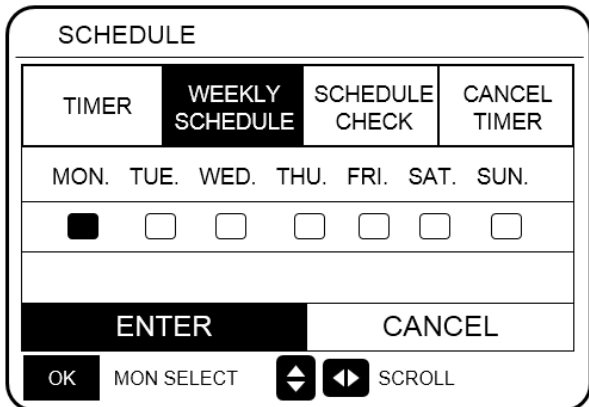

First select the days of the week you wish to schedule. Use "**◀**" and "**▶**" to scroll. Press "OK" to select or unselect the day. "

" " means that the day is selected, " " means that the day is unselected.

Use "**◀**" or "**▶**" to SET, and press "ENTER". The Monday to Friday are selected to be scheduled and they have the same schedule. The following pages will appear:

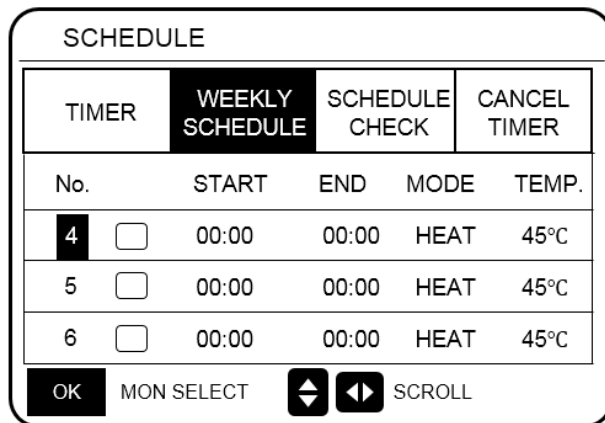
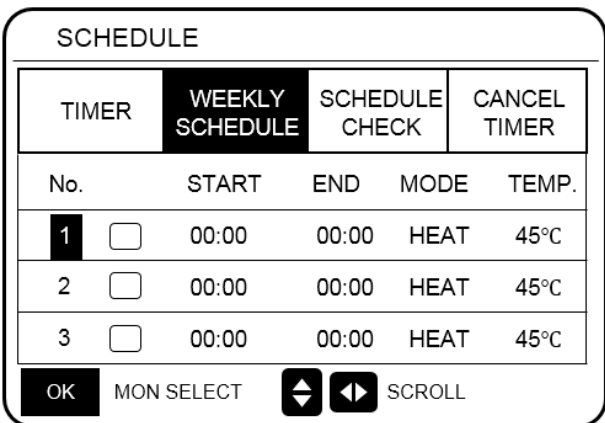

Use "**◀**", "**▶**", "**▼**", "**▲**" to scroll and adjust the time, the mode and the temperature. Timers can be set, including start time and end time, mode and temperature. The mode includes heat mode, cool mode and DHW mode. The setting method refer to timer setting. The end time must be later than the start time. Otherwise this will show that Timer is disabled.

High Temperature Hydro Module



13.3.3 Schedule Check

Schedule check can only check the weekly schedule. Go to "MENU" > "SCHEDULE" > "SCHEDULE' CHECK". Press "OK". The following page will appear:

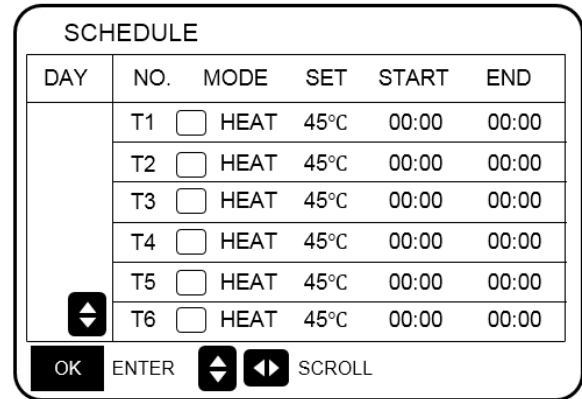
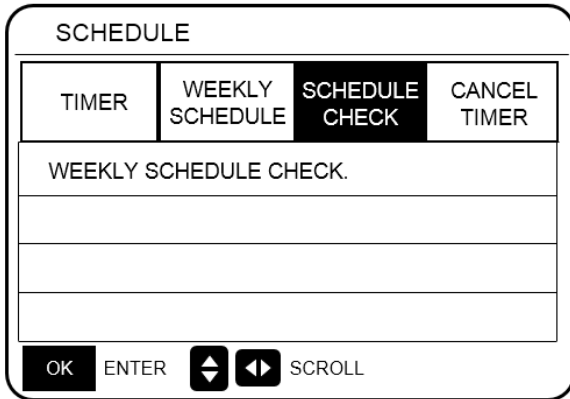

Press "▼", "▲", the timer from Monday to Sunday will appear.

13.3.4 Cancel Timer

Go to "MENU" > "SCHEDULE" > "CANCEL TIMER". Press "OK". The following page will appear:

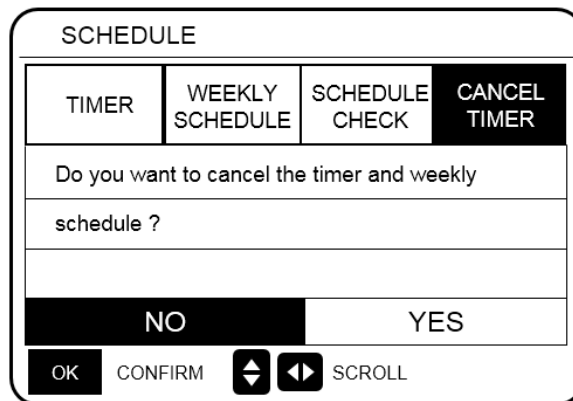

Use "◀", "▶", "▼", "▲" to move to "YES". Press "OK" to cancel the timer. If you want to exit CANCEL TIMER, press "BACK".

If TIMER or WEEKLY SCHEDULE is activated, the timer icon "🕒" or weekly schedule icon "🕒" will display on the home page. If TIMER or WEEKLY SCHEDULE is canceled, icon "🕒" or "🕒" will disappear on the home page.

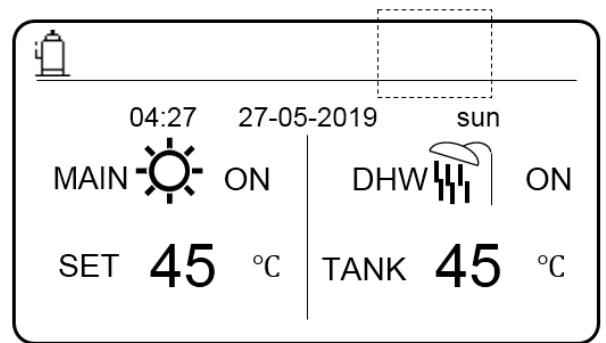
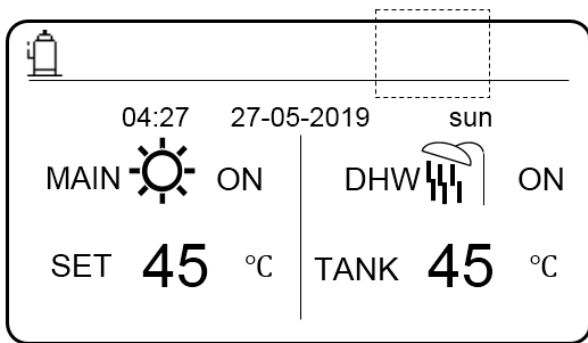
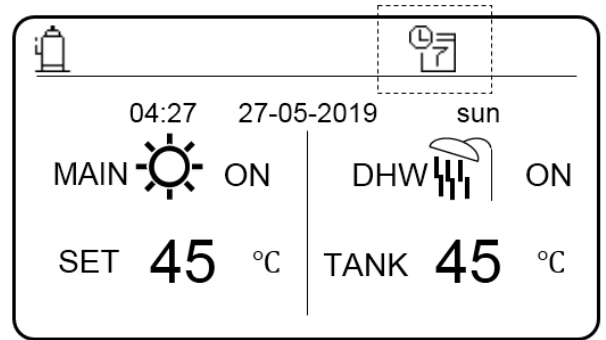
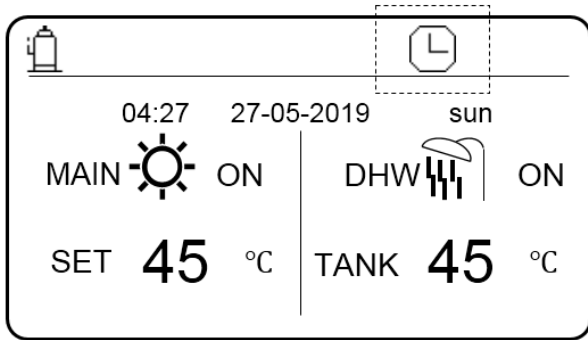

You have to reset TIMER/WEEKLY SCHEDULE, if you change the LEAVING WATER TEMP. to the ROOM TEMP. or you change the ROOM TEMP. to the LEAVING WATER TEMP.

13.4 Options

OPTIONS menu contents as follows:

- 1) SILENT MODE
- 2) HOLIDAY AWAY
- 3) HOLIDAY HOME

13.4.1 Silent Mode

The silent mode is used to reduce the noise of the hydraulic module, which may degrade the capability of the hydraulic module. You can set the hydraulic module to always operate in silent mode or to enter silent mode within a period of time.

- On the main interface, you can check whether silent mode is enabled. If it is, the icon will be displayed on the main interface.
- Choose **MENU > OPTIONS > SILENT MODE**. Press **OK**. The following interface is displayed.

OPTIONS		
SILENT MODE	HOLIDAY AWAY	HOLIDAY HOME
CURRENT STATE		OFF
TIMER		ENTER
SCROLL		

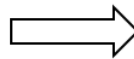

OPTIONS		
SILENT MODE	HOLIDAY AWAY	HOLIDAY HOME
CURRENT STATE		OFF
TIMER		ENTER
SCROLL		

Choose **ON/OFF** to determine whether the silent mode is enabled. If **CURRENT STATE=OFF**, silent mode is invalid. If **CURRENT STATE=ON**, silent mode is invalid. On the **TIMER** page, you can set the time for enabling the silent mode. Two periods of time can be set. The silent mode will be started at the **START** time, and disabled at the **END** time. If **TIMER** is not set, the hydraulic module will remain in silent mode.

OPTIONS		
SILENT MODE	HOLIDAY AWAY	HOLIDAY HOME
CURRENT STATE		ON
TIMER		ENTER
SCROLL		

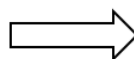

OPTIONS			
SILENT MODE	HOLIDAY AWAY	HOLIDAY HOME	
NO.	START	END	
1	<input type="checkbox"/>	00:00	00:00
2	<input type="checkbox"/>	00:00	00:00
SCROLL			

13.4.2 Holiday Away

If the holiday away mode is enabled, the  icon will be displayed on the main interface. The holiday away mode can prevent water from freezing during holidays and start heating and water heating before you are back home thus guaranteeing comfort and hot water at home.

Go to "MENU" > "OPTIONS" > "HOLIDAY AWAY". Press "OK". The following page will appear.

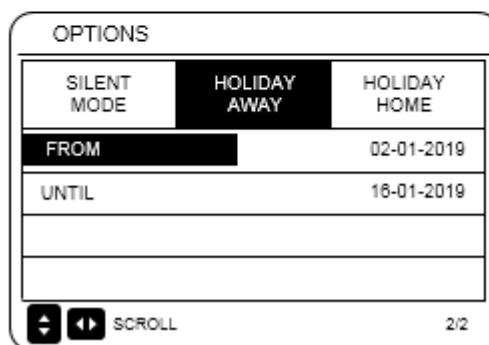
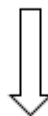
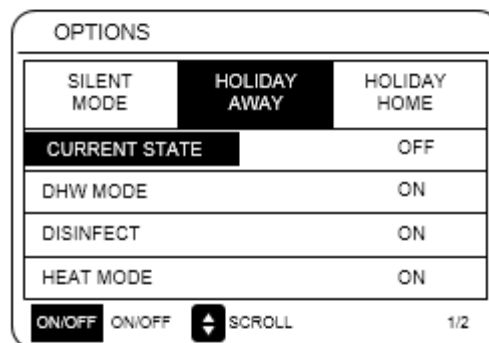
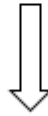
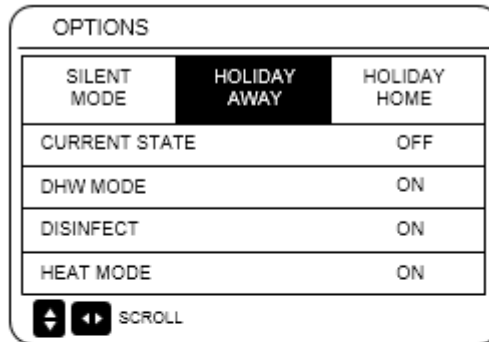

SETTING	VALUE
HOLIDAY AWAY	on
DHW MODE	on
DISINFECT	on
HEAT MODE	on
FROM	02-01-2019
UNTIL	16-01-2019

When DISINFECT is set to ON, and you set the disinfection mode, the hydraulic module will automatically perform disinfection at the set disinfection time prior to the end of the holiday. For example, if FROM=2019-01-02, UNTIL=2019-01-16, and disinfection time is set to 23:00 on Friday, disinfection begins from 23:00 on 2019-01-11. If you do not set the disinfection mode, the hydraulic module will forcedly enter disinfection mode at 22:00 on the day before the end of the holiday. If you do not set the disinfection mode, the hydraulic module will begin disinfection from 22:00 on 2019-01-19. After the hydraulic module exits disinfection mode, the wired controller will send the heat mode start-up command and DHW mode start-up command to the hydraulic module. TwoutS=TwoutS_H.A_H indicates the heat mode, while TtankS=TtankS_H.A_DHW indicates the DHW mode. TwoutS_H.A_H and TtankS_H.A_DHW are set on the FOR SERVICEMAN interface of the wired controller.

Notes:

- In holiday mode, timer and weekly schedule are invalid until the hydraulic module exits from holiday mode.
- The CURRENT STATE option determines whether to enable holiday mode. If CURRENT STATE = OFF, HOLIDAY AWAY = OFF. If CURRENT STATE = ON, HOLIDAY AWAY = ON.
- The multiple set point is invalid when the hydraulic module operates in holiday mode.
- If disinfection mode is set in holiday mode, the hydraulic module will enter the disinfection mode at 22:00 on the day before the end of the holiday mode.
- In holiday mode, the weather temperature curve is invalid until the hydraulic module exits from holiday mode.
- In holiday mode, Preset Temp. is invalid until the hydraulic module exits from holiday mode.

If you operate the wired controller in holiday mode, the following prompt is displayed:

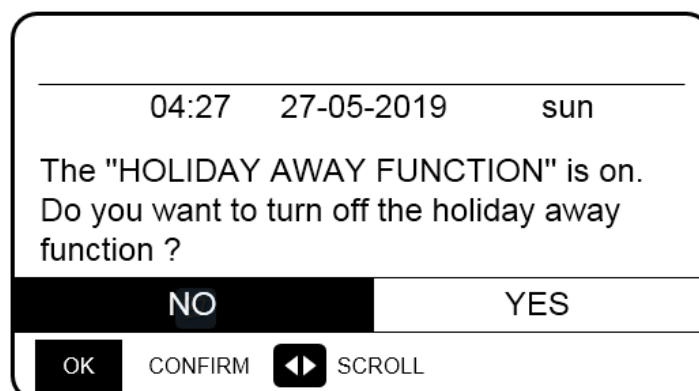

13.4.3 HOLIDAY HOME Mode

In holiday home mode, the hydraulic module can operate according to the schedule settings of the holiday mode without affecting the normal schedule.

Period	Then...
Before and after your holiday	Your normal schedules will be used.
During your holiday	The configured holiday setting will be used.

If the holiday home mode is activated,  will display on the home page.

Go to "MENU" > "OPTIONS" > "HOLIDAY HOME". Press "OK". The following page will appear:

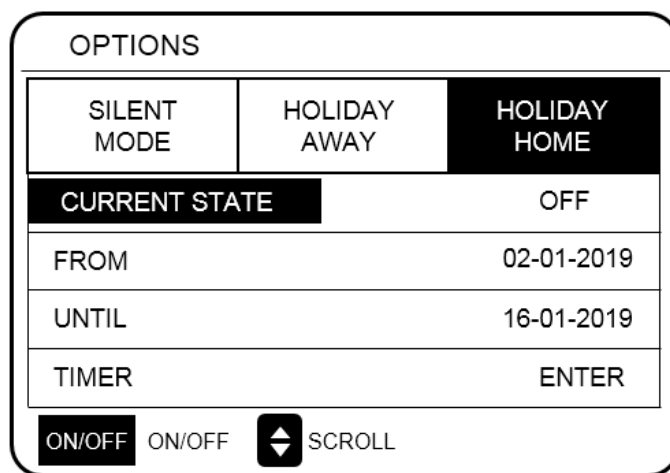

Use "ON/OFF" to select "OFF" or "ON" and use "◀", "▶", "▼", "▲" to scroll and adjust.

If the CURRENT STATE is OFF, the HOLIDAY HOME is OFF. If the CURRENT STATE is ON, the HOLIDAY HOME is ON. Use "▼" and "▲" to adjust the date. Before and after your holiday, your normal schedule will be used. During your holiday, you will save energy and prevent your house from freezing.

Notes for installers and service engineers

Important Points

- If both HOLIDAY AWAY and HOLIDAY HOME are set to ON, FROM and UNTIL set on the HOLIDAY AWAY page cannot coincide or overlap with those set on the HOLIDAY HOME page. If they coincide or overlap, the following page is displayed:

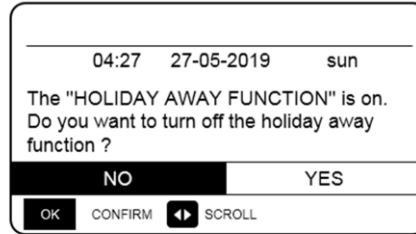

Press OK TO go back to the holiday away page.

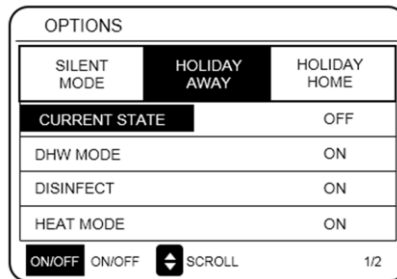
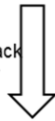

13.5 Child Lock

The CHILD Lock function is used to prevent children error operation. The mode setting and temperature adjusting can be locked or unlocked by using CHILD LOCK function.

Go to " MENU " > " CHILD LOCK ". The page is displayed:

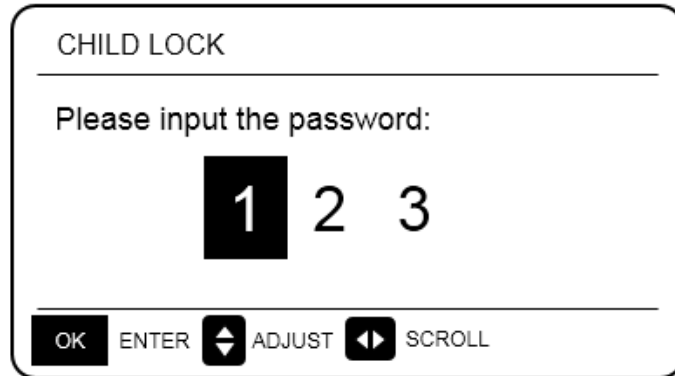

Input the correct password, and the following page will appear:

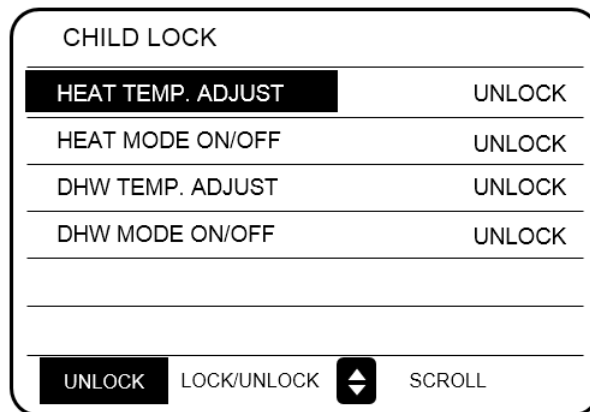

Use "▼" and "▲" to scroll and "ON/OFF" to select LOCK or UNLOCK.

The heat/DHW temperature can't be adjusted when the HEAT TEMP. ADJUST/DHW TEMP. ADJUST is locked. If you want to adjust the heat/DHW temperature when heat/DHW temperature is locked, the following page will appear:

The heat/DHW mode can't turn on or off when the HEAT/DHW MODE ON/OFF is locked. If you want to turn the heat/DHW mode on or off when HEAT/DHW MODE ON/OFF is locked, the following page will appear:

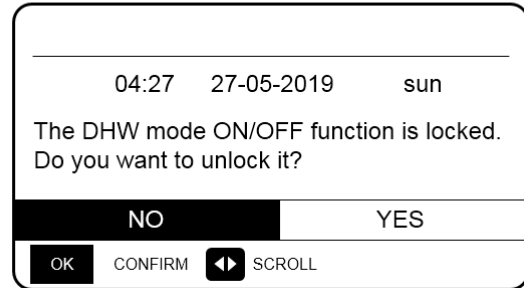
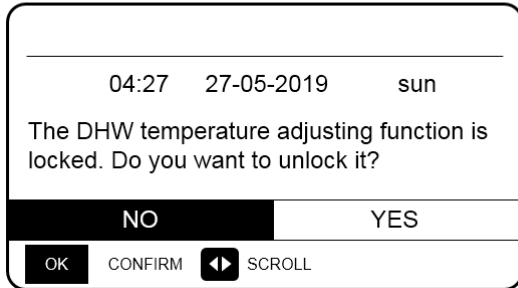
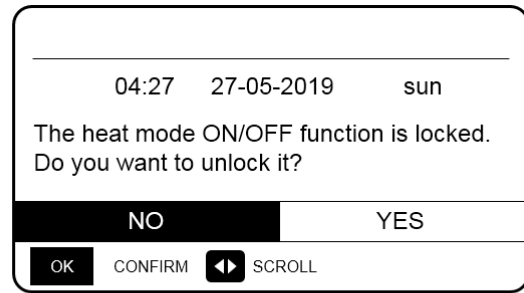
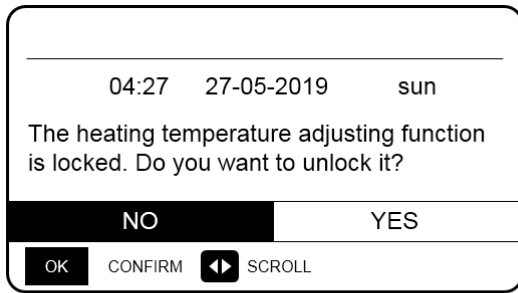

If you press NO, you will return to the home page. If you press YES, you will go to the CHILD LOCK page.

13.6 Service Information

13.6.1 About Service Information

Service information menu contents are as follows:

- 1) SERVICE CALL
- 2) ERROR CODE
- 3) PARAMETER
- 4) DISPLAY

13.6.2 How to go to Service Information Menu

Go to "MENU" > "SERVICE INFORMATION". Press "OK". The following page will appear:

The service call can show the service phone or mobile number. The installer can input the phone number. See "FOR SERVICEMAN".

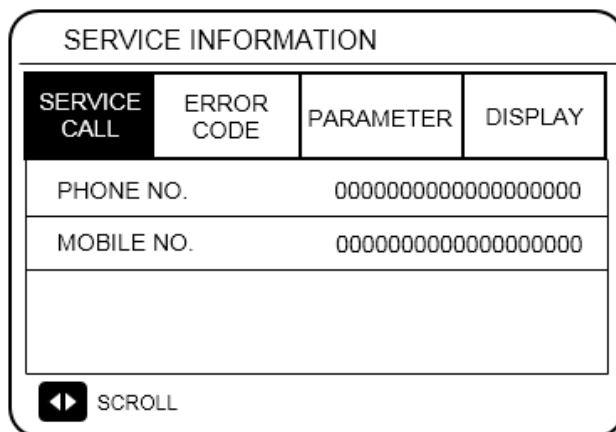

An error code is used to show when the fault happened and show the meaning of the error code.

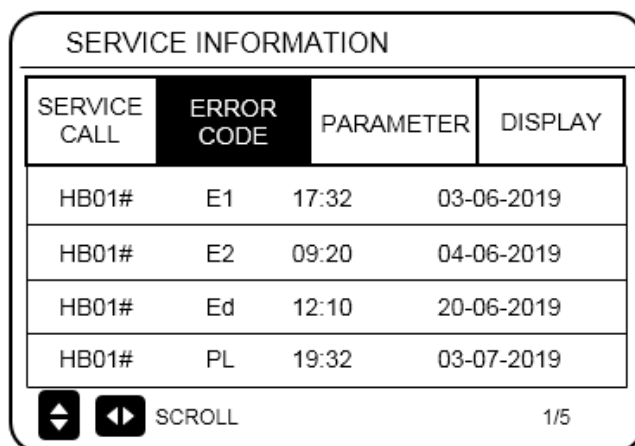

High Temperature Hydro Module

Press OK and the following page will appear:

SERVICE INFORMATION			
SERVICE CALL	ERROR CODE	PARAMETER	DISPLAY
HB01#	E1	17:32	03-06-2019
HB01#	E2	09:20	04-06-2019
HB01#	Ed	12:10	20-06-2019
HB01#	PL	19:32	03-07-2019

1/5

Press OK to show the mean of the error code:

04:27 27-05-2019 sun

HB01# E1
Communication fault between controller and hydro box.

Please contact your dealer.

 CONFIRM

NOTE:

A total of twenty fault codes can be recorded.

The parameter function is used to display the main parameter, and there are two pages to show the parameter:

SERVICE INFORMATION			
SERVICE CALL	ERROR CODE	PARAMETER	DISPLAY
		ROOM SET TEMP.	--°C
		MAIN SET TEMP.	45°C
		TANK SET TEMP.	50°C
		ROOM ACTUAL TEMP.	--°C

1/2

SERVICE INFORMATION			
SERVICE CALL	ERROR CODE	PARAMETER	DISPLAY
		MAIN ACTUAL TEMP.	25°C
		TANK ACTUAL TEMP.	55°C

SCROLL 2/2

The display function is used to set the interface:

SERVICE INFORMATION			
SERVICE CALL	ERROR CODE	PARAMETER	DISPLAY
		TIME	18:39
		DATE	03-06-2019
		LANGUAGE	EN
		BACKLIGHT	ON

SCROLL 1/2

SERVICE INFORMATION			
SERVICE CALL	ERROR CODE	PARAMETER	DISPLAY
		BUZZER	ON
		SCREEN LOCK TIME	300 SEC

ON/OFF SCROLL 2/2

Use "OK" to enter and use "◀", "▶", "▼", "▲" to scroll.

13.7 Operation Parameters

Spot check the operating parameters of the hydraulic module and some operating parameters of the ODU. This menu is for installer or service engineer reviewing the operation parameter of hydro box and ODU units.

- At the home page, go to "MENU" > "OPERATION PARAMETERS".
- Press "OK". There are six pages for the operating parameter as following. Use "▼", "▲" to scroll.

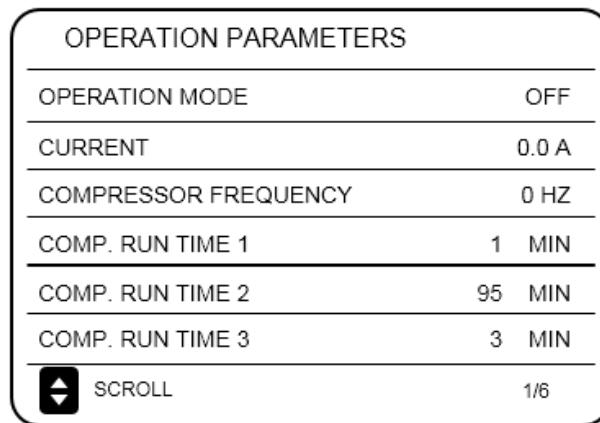
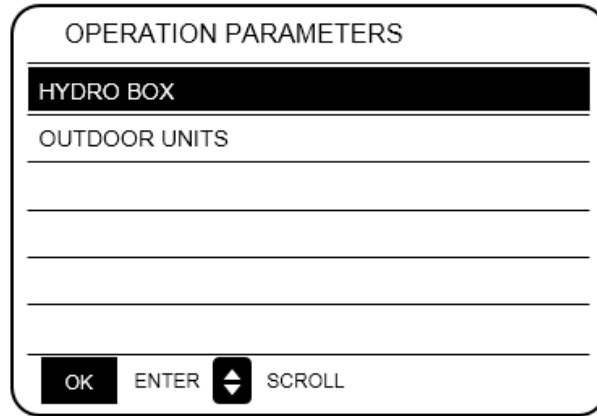

The parameters of high temperature hydraulic module are as follows:

OPERATION PARAMETERS	
COMP. RUN TIME 4	80 Hrs
EXPANSION VALVE 1	0 P
EXPANSION VALVE 2	0 P
TWOUT	25 °C
TWIN	25 °C
TTANK	25 °C
SCROLL	2/6

OPERATION PARAMETERS	
SC	25 °C
PRIMARY CURRENT	0.0 A
SECONDARY CURRENT	0.0 A
PRIMARY VOLTAGE	0 V
POWER CONSUMPTION	0 W
HEAT POWER	0 W
SCROLL	5/6

OPERATION PARAMETERS	
TCS	25 °C
PC	0 kPa
PE	0 kPa
TC	25 °C
TE	25 °C
T7C	25 °C
SCROLL	3/6

OPERATION PARAMETERS	
HYDRO BOX SOFTWARE	V00
CONTROLLER SOFTWARE	V01
SCROLL	6/6

OPERATION PARAMETERS	
T7	25 °C
T3	25 °C
T2A	25 °C
TF	25 °C
DSH	25 °C
SSH	25 °C
SCROLL	4/6

High Temperature Hydro Module

The parameters of ODU units are as follows:

OPERATION PARAMETERS

HYDRO BOX

OUTDOOR UNITS

OK ENTER SCROLL

OPERATION PARAMETERS

ODU2_INV	0 HZ
ODU2_PC	0 kPa
ODU2_PE	0 kPa
ODU2_DSH	0 °C
ODU2_T4	25 °C
ODU2_SOFTWARE	V01

SCROLL 1/3

OPERATION PARAMETERS

ODU1_INV	0 HZ
ODU1_PC	0 kPa
ODU1_PE	0 kPa
ODU1_DSH	0 °C
ODU1_T4	25 °C
ODU1_SOFTWARE	V01

SCROLL 1/3

OPERATION PARAMETERS

ODU3_INV	0 HZ
ODU3_PC	0 kPa
ODU3_PE	0 kPa
ODU3_DSH	0 °C
ODU3_T4	25 °C
ODU3_SOFTWARE	V01

SCROLL 1/3

Parameter	Meaning
OPERATION MODE	Operating Mode
CURRENT	Current
COMPRESSOR FREQUENCY	Compressor frequency
COMP. RUN TIME 1	Compressor operating time
COMP. RUN TIME 2	
COMP. RUN TIME 3	
COMP. RUN TIME 4	
EXPANSION VALVE 1	EXV1 openness
EXPANSION VALVE 2	EXV2 openness
TWOUT	Water outlet temperature
TWIN	Water inlet temperature
TTANK	Water tank temperature
TCS	Desired saturation temperature
PC	Discharge pressure
PE	Air return pressure
TC	Discharge pressure saturation temperature
TE	Air return pressure saturation temperature
T7C	Discharge temperature
T7	Return air temperature
T3	Cold outlet temperature
T2A	Liquid pipe temperature at R410a side
TF	Module temperature
DSH	Discharge Superheat
SSH	Air return superheat
SC	Supercooling degree of liquid pipe at R410a side
PRIMARY CURRENT	Primary current
SECONDARY CURRENT	Secondary current
PRIMARY VOLTAGE	Primary voltage
POWER CONSUMPTION	Secondary voltage
HEAT POWER	Heating ability

13.8 User Settings

Code	Description	Default Value	Min. Value	Max. Value	Adjustment Step	Unit
TwoutS	Water outlet temperature of heating mode set on the main interface	45	25	80	1	°C
TaS	Room temperature of heating mode set on the main interface	24	17	30	1	°C
TtankS	Water tank temperature of DHW mode set on the main interface	50	25	80	1	°C
HEAT	Heat mode on/off: 0 = Off, 1 = On	0	0	1	1	/
DHW	DHW mode on/off: 0 = Off, 1 = On	0	0	1	1	/
PRESET TEMP. TIMER1	PRESET TEMP. timer 1 on/off: 0 = Off , 1 = On	0	0	1	1	/
PRESET TEMP. TIME1	PRESET TEMP. time 1	00:00	00:00	23:50	1/10	h/min
Temper.1	PRESET TEMP. 1	45	25	80	1	°C
PRESET TEMP. TIMER2	PRESET TEMP. timer 2 on/off: 0 = Off , 1 = On	0	0	1	1	/
PRESET TEMP. TIME2	PRESET TEMP. time 2	00:00	00:00	23:50	1/10	h/min
Temper.3	PRESET TEMP. 2	45	25	80	1	°C
PRESET TEMP. TIMER3	PRESET TEMP. timer 2 on/off: 0 = Off , 1 = On	0	0	1	1	/
PRESET TEMP. TIME3	PRESET TEMP. time 3	00:00	00:00	23:50	1/10	h/min
Temper.3	PRESET TEMP. 3	45	25	80	1	°C
PRESET TEMP. TIMER4	PRESET TEMP. timer 3 on/off: 0 = Off , 1 = On	0	0	1	1	/
PRESET TEMP. TIME4	PRESET TEMP. time 4	00:00	00:00	23:50	1/10	h/min
Temper.4	PRESET TEMP. 4	45	25	80	1	°C
PRESET TEMP. TIMER5	PRESET TEMP. timer 4 on/off: 0 = Off , 1 = On	0	0	1	1	/
PRESET TEMP. TIME5	PRESET TEMP. time 5	00:00	00:00	23:50	1/10	h/min
Temper.5	PRESET TEMP. 5	45	25	80	1	°C
PRESET TEMP. TIMER6	PRESET TEMP. timer 6 on/off: 0 = Off , 1 = On	0	0	1	1	/

PRESET TEMP. TIME6	PRESET TEMP. time 6	00:00	00:00	23:50	1/10	h/min
Temper.6	PRESET TEMP. 6	45	25	80	1	°C
weather temp. set	Temperature setting curve on/off: OFF = 0, ON = 1	0	0	1	1	/
shift value	Temperature setting curve shift value	0	-5	5	1	°C
multiple set point 1 required temp.	Sets water temperature at multiple set point 1	65	25	80		1 °C
multiple set point 2 required temp.	Sets water temperature at multiple set point 2	35	25	80		1 °C
DISINFECT CURRENT STATE	Disinfection on/off: OFF = 0, ON = 1	0	0	1	1	/
DISINFECT OPERATE DAY	Disinfection week	FRI	MON	SUN	1	/
DISINFECT START	Start time for disinfection	23:00	00:00	23:50	1/10	h/min
DHW PUMPTIMER1-16	Pipeline water return pump timer on/off: OFF = 0, ON = 1	0	0	1	1	/
DHW PUMP START 1-16	Pipeline water return pump start time: 1-16	00:00	00:00	23:50	1/10	h/min
TIMER1-TIMER6	Timers 1-6 on/off: 0 = Off , 1 = On	0	0	1		1 /
TIMER1-TIMER6 START	Timers 1-6 start time	00:00	00:00	23:50	1/10	h/min
TIMER1-TIMER6 END	Timers 1-6 end time	00:00	00:00	23:50	1/10	h/min
TIMER MODE 1-6	Timer mode: 0 = HEAT, 3 = DHW	0	0	3		1 /
TIMER TEMP. 1-6	Temperature setting timer	45	25	80	1	°C
CANCEL TIMER	Cancels all the defined timers	0	0	1	1	/
SILENT MODE CURRENT STATE	Silent mode on/off: 0 = Off , 1 = On	0	1	1	1	/
SILENT TIMER	Silent mode timer on/off: 0 = Off , 1 = On	1	0	1	1	/
SILENT MODE TIMER START 1	Silent mode timer start time 1	12:00	00:00	23:50	1/10	h/min
SILENT MODE TIMER END 1	Silent mode timer end time 1	15:00	00:00	23:50	1/10	h/min
SILENT MODE TIMER START 2	Silent mode timer start time 2	22:00	00:00	23:50	1/10	h/min
SILENT MODE TIMER ENDT 2	Silent mode timer end time 2	07:00	00:00	23:50	1/10	h/min
HOLIDAY AWAY CURRENT STATE	Holiday away mode on/off: 0 = Off , 1 = On	0	0	1	1	/

High Temperature Hydro Module



HOLIDAY AWAY DHW MODE	Holiday away DHW mode on/off: 0 = Off , 1 = On	1	0	1	1	/
HOLIDAY AWAY DISINFECT	Holiday away disinfection mode on/off: 0 = Off , 1 = On	1	0	1	1	/
HOLIDAY AWAY HEAT MODE	Holiday away heat mode on/off: 0 = Off , 1 = On	1	0	1	1	/
HOLIDAY AWAY FROM	Holiday away start date	Current date + 1	1/1/2018	1/1/2100	1	/
HOLIDAY AWAY UNTIL	Holiday away end date	Current date + 8	1/1/2018	1/1/2100	1	/
HOLIDAY home CURRENT STATE	Holiday home mode on/off: 0 = Off , 1 = On	0	0	1	1	/
HOLIDAY home FROM	Holiday home start date	Current date	1/1/2018	1/1/2100	1	/
HOLIDAY home UNTIL	Holiday home end date	Current date + 7	1/1/2018	1/1/2100	1	/
HOLIDAY home TIMER	Holiday home timer on/off: 0 = Off , 1 = On	0	0	1	1	/
CURRENT TIME	Current time	00:00	00:00	23:59	1/10	h/min
CURRENT DATE	Current date	1/1/2018	1/1/2018	1/1/2100	1	/
LANGUAGE	Language: EN = 0 , FR = 1 , IT = 2 , SP = 3 , PL = 4 , DE = 5, TR = 6	0	0	5	1	/
BACKLIGHT	Backlight on/off: 0 = Off , 1 = On	1	0	1	1	/
BUZZER	Buzzer on/off: 0 = Off , 1 = On	1	0	1	1	/
SCREEN LOCK TIME	Screen locking time	120	60	300	10	Second

13.9 On- Site FOR SERVICEMAN Settings

13.9.1 About FOR SERVICEMAN

FOR SERVICEMAN is used for installers and service engineers.

- Setting the function of equipment.
- Setting the parameters.

13.9.2 How to go to "FOR SERVICEMAN"

Go to "MENU" > "FOR SERVICEMAN". Press "OK".

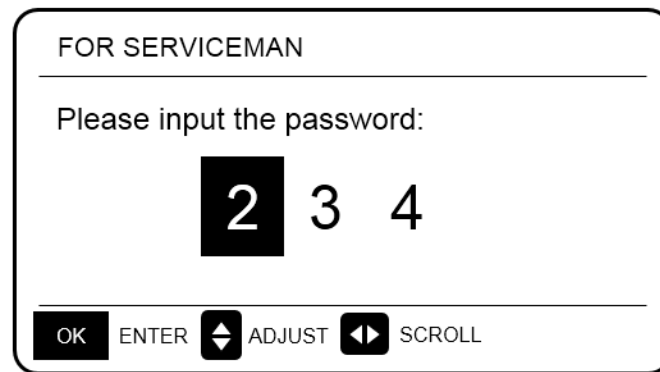

- The FOR SERVICEMAN is used for installers or service engineers. It is NOT intended for home owners to alter setting with this menu.
- It is for this reason that password protection is required to prevent unauthorised access to the service settings.
- The password is 234.

13.9.3 How to exit "FOR SERVICEMAN"

If you have set all the parameters. Press "BACK", and the following page will appear:

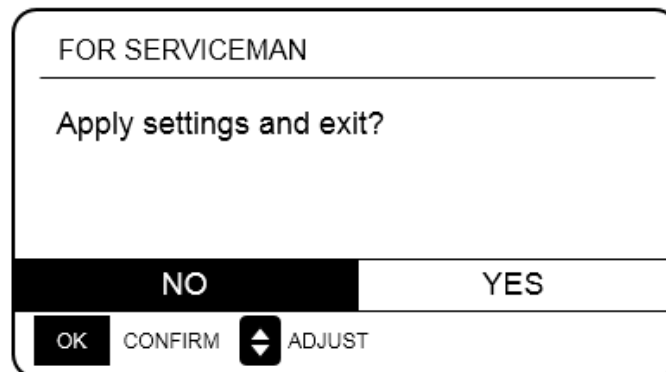

Select "YES" and press "OK" to exit the FOR SERVICEMAN. After exiting the FOR SERVICEMAN, the unit will be turned off.

High Temperature Hydro Module



13.9.4 Meanings of each setting item

No.	Code	Description	Default Value	Min. Value	Max. Value	Adjustment Step	Unit
1	DHW MODE SETTING	DHW MODE	DHW mode on/off: 0 = NON , 1 = YES	1	0	1	1 /
2		DISINFECT MODE	Disinfection on/off: 0 = NON , 1 = YES	1	0	1	1 /
3		DHW PRIORITY	Water heating priority on/off: 0 = NON , 1 = YES	1	0	1	1 /
4		dTankSH	Power-on return difference of water heating	5	2	10	1 °C
5		TtankS_DI	Sets temperature for disinfection	65	60	70	1 °C
6		t_DI_HIGHTEMP.	Duration of disinfection at high temperature	15	5	60	5 MIN
7		t_DI_MAX	Longest disinfection duration	210	90	300	5 MIN
8		DHW PUMP RUNNING TIME	Time-based control of pipeline water return pump on/off: 0 = Off, 1 = On	1	0	1	1 /
9	HEAT MODE SETTING	HEAT MODE	Heat mode on/off: 0 = NON , 1 = YES	1	0	1	1 /
10		LEAVING WATER TEMP.	Water outlet temperature control on/off: 0 = NON , 1 = YES	1	0	1	1 /
11		ROOM TEMP.	Room temperature control on/off: 0 = NON , 1 = YES	0	0	1	1 /
12		t_ODU_T4_FRESH_H	Weather temperature curve T4 refresh time in heat mode	0.5	0.5	6	0.5 hours
13		dTwoutSH	Power-on return difference in heat mode (Water outlet temperature control)	5	2	10	1 °C
14		dTaSH	Power-on return difference in heat mode (ambient temperature sensor control Ta)	2	1	10	1 °C
15	WEATHER TEMP. SETTING	L_weather_Twout	Water outlet temperature at low air temperature	70	25	80	1 °C
16		H_weather_Twout	Water outlet temperature at high air temperature	45	25	80	1 °C
17		L_ODU_T4	Low ambient temperature	-10	-20	5	1 °C
18		H_ODU_T4	High ambient temperature	15	10	20	1 °C

19	MULTIPLE SET POINT	multiple set point 1	Multiple set point 1 on/off: 0 = OFF, 1 = YES	0	0	1	1	/
20	SETTING	multiple set point 2	Multiple set point 2 on/off: 0 = OFF, 1 = YES	0	0	1	1	/
21	HOLIDAY AWAY	TwoutS_H.A_H	Water outlet temperature of holiday mode	25	28	80	1	°C
22	SETTING	TtankS_H.A_DHW	Water tank temperature of holiday mode	40	25	80	1	°C
23	HEAT RECOVERY MODE	HEAT RECOVERY	Heat recovery mode on/off: 0 = NON , 1 = YES	1	0	1	1	/
24	SRTTING	Ttank_recovery_max	Max. heat recovery water tank temperature	70	45	80	1	°C
25	POWER INPUT LIMITATION	POWER INPUT LIMITATION	Sets input power limitation gear: 0 = Not limited, 1 = Gear 1, 2 = Gear 2, 3 = Gear 3	0	0	3	1	/
26	SMART GRID	SMART GRID	Sets smart grid on/off: 0 = NON , 1 = YES	0	0	1	1	/
27		Ttank_smartgrid_max	Sets the highest water tank temperature of the smart grid	70	45	80	1	°C
28	HYDRO BOX ADDERSSING	HYDRO BOX ADDERSSING	Sets hydraulic module address	0	0	63	1	/
29	TEST RUN	VACUUM PUMPING	Sets vacuumizing mode on/off	0	0	1	1	/
30		CIRCULATED PUMP RUNNING	Sets external water pump on/off	0	0	1	1	/
31		DHW PUMP RUNNING	Sets water tank and pump on/off	0	0	1	1	/

High Temperature Hydro Module



13.9.5 Setting of Special Functions

Maximum Power Limitation Function

This function can limit the power consumption of the hydraulic module. Choose **MENU > FOR SERVICEMAN > POWER INPUT LIMITATION**. Press **OK**. The following interface is displayed.

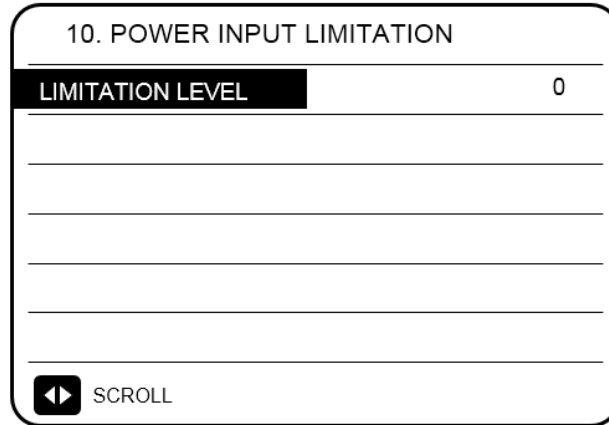

Select speed. 0 = Not limited; 1 = Speed 1; 2 = Speed 2; 3 = Speed 3.

Speed 0: It indicates that the maximum current for hydraulic module operation is 16 A.

Speed 1: It indicates that the maximum current for hydraulic module operation is 15 A.

Speed 2: It indicates that the maximum current for hydraulic module operation is 14 A.

Speed 3: It indicates that the maximum current for hydraulic module operation is 13 A.

Heat recovery Function

This function will automatically enable the heat recovery function of the hydraulic module to produce hot water when the start-up capacity of the chiller's IDU is great. Choose **MENU > FOR SERVICEMAN > HEAT RECOVERY MODE SETTING**. Press **OK**. The following interface is displayed.

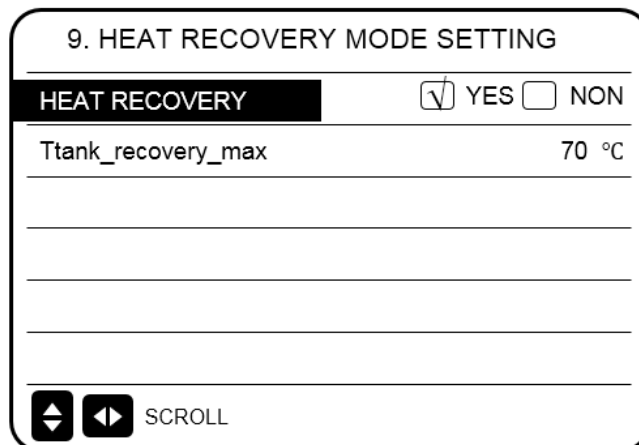

HEAT RECOVERY=YES indicates that the heat recovery function is enabled. HEAT RECOVERY=NON indicates that heat recovery function is disabled.

Ttank_recovery_max indicates that the desired tank temperature of the heat recovery function is set.

14 Menu Structure Overview

14.1 Structure

- | |
|---|
| <ol style="list-style-type: none"> 1. Heat mode 2. Domestic hot water(DHW) 3. Schedule 4. Options 5. Child lock 6. Service information 7. Operation parameter 8. For serviceman |
|---|

- | |
|--|
| <ol style="list-style-type: none"> 1. Preset temp. 2. Weather temp. set |
| <ol style="list-style-type: none"> 1. Disinfect 2. DHW pump |
| <ol style="list-style-type: none"> 1. Timer 2. Weekly schedule 3. Schedule check 4. Cancel timer |
| <ol style="list-style-type: none"> 1. Silent mode 2. Holiday away 3. Holiday home |
| <ol style="list-style-type: none"> 1. Heat temp. adjust 2. Heat mode on/off 3. DHW temp. adjust 4. DHW mode on/off |
| <ol style="list-style-type: none"> 1. Service call 2. Error code 3. Parameter 4. Display |
| <ol style="list-style-type: none"> 1. Hydro box 2. Outdoor units |
| <ol style="list-style-type: none"> 1. DHW mode setting 2. Heat mode setting 3. Weather temp. setting 4. Multiple set point setting 5. Holiday away setting 6. Service call 7. Restore factory setting 8. Test run 9. Heat recovery mode setting 10. Power input limitation 11. SMART GRID 12. Hydro box addressing |

- | |
|---|
| <ol style="list-style-type: none"> 1. DHW MODE 2. Disinfect mode 3. DHW priority 4. dTankSH 5. TtankS_DI 6. t_DI_HIGHTEMP. 7. t_DI_MAX 8. DHW PUMP RUNNING TIME |
| <ol style="list-style-type: none"> 1. HEAT MODE 2. LEAVING WATER TEMP. 3. ROOM TEMP. 4. t_ODU_t4_FRESH_H 5. dTwoutSH 6. dTaSH |
| <ol style="list-style-type: none"> 1. L_weather_Twout 2. H_weather_Twout 3. L_ODU_T4 4. H_ODU_T4 |
| <ol style="list-style-type: none"> 1. Multiple set point 1 2. Multiple set point 2 |
| <ol style="list-style-type: none"> 1. TwoutS_HA_H 2. TtankS_HA_DHW |
| <ol style="list-style-type: none"> 1. HEAT RECOVERY 2. Ttank_recovery_max |
| <ol style="list-style-type: none"> 1. POWER INPUT LIMITATION |
| <ol style="list-style-type: none"> 1. SMART GRID 2. Ttank_smartgrid_max |
| <ol style="list-style-type: none"> 1. HYRDO BOX ADDRESSING |

15 Maintenance

Note:

Before repair and maintenance, ensure that the hydraulic module is powered off.

- Water pressure

Check if the water pressure is above 0.3 bar. Add water if necessary.

- Water filter

Clean the water filter.

- Water pressure relief valve

Check for correct operation of the pressure relief valve by turning the red knob along the valve counter-clockwise:

1. If you do not hear a clacking sound, contact your local dealer.

2. If water keeps running out of the unit, close both the water inlet and outlet shut-off valves first and then contact your local dealer.

- Pressure relief valve hose

Check that the pressure relief valve hose is positioned appropriately to drain the water. If the drain pan kit is installed, make sure that the pressure relief valve hose end is positioned in the drain pan.

- Auxiliary heater vessel insulation cover

Check that the auxiliary heater insulation cover is fastened tightly around the auxiliary heater vessel.

- Sanitary hot water tank pressure relief valve (field supply)

Applies only to installations with a sanitary hot water tank. Check for correct operation of the pressure relief valve on the sanitary hot water tank.

- Sanitary hot water electric heater

Applies only to installations with a sanitary hot water tank. It is advisable to remove lime buildup on the electric heater to extend its life span, especially in regions with hot water. To do so, drain the sanitary hot water tank, remove the electric heater from the sanitary hot water tank and immerse in a bucket (or similar) with lime-removing product for 24 hours.

- Indoor unit control box

1. Carry out a through visual inspection of the control box and look for obvious defects such as loose connections or defective wiring.







2. Check for correct operation of contactors by the use of an ohmmeter. All of these contactors must be in open position.

16 Error Code Table

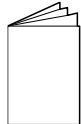
Error Code	Item
EE	EPROM failure
FE	Undefined address of hydraulic module
C7	Protection against excessively high temperature of the inverter module
E9	Unmatched compressor model
H4	Report error H4 after 3 x L0 or L1 failure is displayed.
H5	Low pressure protection (Unrecoverable)
H6	Discharge temperature protection (Unrecoverable)
1F6	EXV1 R134A electronic expansion valve failure
2F6	EXV2 R410A electronic expansion valve failure
E1	Communication failure between wired controller and hydraulic module
E8	Water flow failure
F3	Twout water outlet temperature sensor failure
F9	Twin water inlet temperature sensor failure
F5	Ttank water tank temperature sensor failure
E7	T7C discharge temperature sensor failure
FA	T7 return air temperature sensor failure
Fb	TF module temperature failure
FC	Liquid pipe temperature sensor failure at R410A side of T2A evaporation condenser
Fd	T3 cold outlet temperature sensor failure
F8	Ta room temperature sensor wired controller failure
H8	High-pressure sensor failure
Hb	Low-pressure sensor failure
E2	Communication failure between hydraulic module and ODU
H0	Communication failure between main control chip and driver chip
E0	Slave unit communication failure (only valid to group control)
Ed	ODU failure
E5	Voltage protection failure
PP	Insufficient superheat degree protection
P1	High pressure protection
P2	Low pressure protection
P3	Compressor overcurrent protection (secondary current protection)
P4	T7C discharge temperature protection
PL	Module high-temperature protection
F1	Loop relay protection of module plate

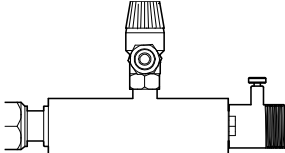
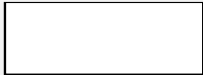
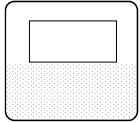
17 Accessories

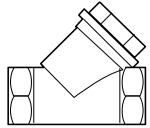
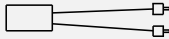
Midea VR High Temperature Hydro Module

Installation Manual	1		—————
User Manual	1		—————
Connecting pipe assembly (Including safety valve)	1		Connected to the water-outlet pipe side
Water discharge hose	1		Connected to the outlet of the drainage pan
Wired controller	1		To control the unit
Water temperature sensor	1		For detecting water tank temperature
Y-shaped filter	1		Connected to the water-inlet pipe side
Magnetic ring	2		—————
Cable tie	6		Fixing the wire and magnetic ring

**Commercial Air Conditioner Division
Midea Group**

Add.: Midea Headquarters Building, 6 Midea Avenue, Shunde, Foshan, Guangdong, China

Postal code: 528311

Tel: +86-757-26338346; **Fax:** +86-757-22390205

cac.midea.com / global.midea.com

Note: Product specifications change from time to time as product improvements and developments are released and may vary from those in this document.

