

AIR CONDITIONER

REMOTE CONTROLLER ILLUSTRATION

The design and specifications are subject to change without prior notice for product improvement. Consult with the sales agency or manufacturer for details.

CR154-RG58B1(A2)
2020550A9309

Thank you very much for purchasing our air conditioner.
Please read this owner's manual carefully before using
your air conditioner.

CONTENTS

Remote controller Specifications.....	2
Operation buttons	3
Indicators on LCD	6
How to use the buttons	7
Auto operation.....	7
Cooling/Heating/Fan operation.....	7
Dehumidifying operation	8
Timer operation.....	9
Handling the remote controller	13

NOTE:

- Buttons design is based on typical model and might be slightly different from the actual one you purchased, the actual shape shall prevail.
- All the functions described are accomplished by the unit. If the unit has no this feature, there is no corresponding operation happened when press the relative button on the remote controller.
- When there are wide differences between “Remote controller Illustration” and “USER’S MANUAL” on function description, the description of “USER’S MANUAL” shall prevail.

Remote Controller Specifications

Model	RG58B1/BGE, RG58B2/BGE, RG58A2/BGEF, RG58A4/BGEF
Rated Voltage	3.0V(Dry batteries R03/LR03 × 2)
Signal Receiving Range	8m
Environment	-5°C, 60°C

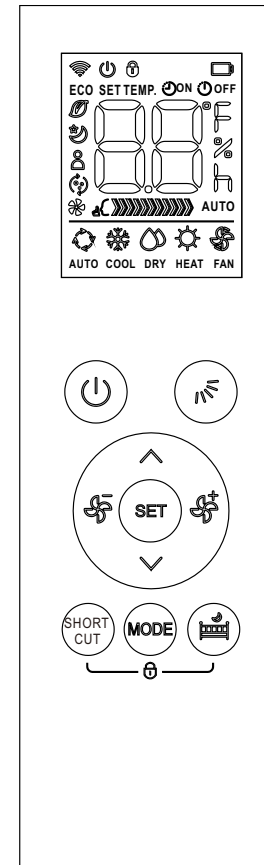

Operation of buttons

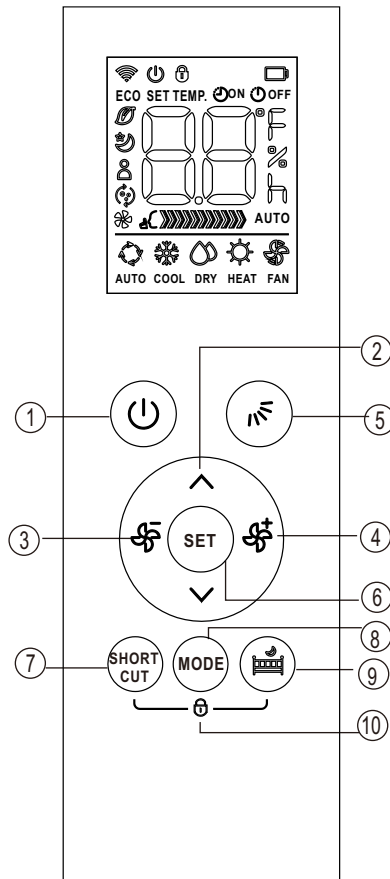

- 1 **ON/OFF Button** ()
This button turns the air conditioner ON and OFF.
- 2 **UP Button** ()
Press this button to increase the set temperature or Timer setting hours.
- 3 **DOWN Button** ()
Push this button to decrease the set temperature or Timer setting hours.
NOTE:
 - When the air conditioner operates under heating mode with the set temperature of 17°C, pressing button continuously for two times will activate 8 Degree heating. The indoor unit display shows "FP".
- 4 **FAN Button** ()
Used to select the fan speed in four steps: HIGH → MED → LOW → AUTO
NOTE:
 - Hold down this button for at least 2 seconds to activate/cancel **Silent** mode. Due to low frequency operation of compressor, it may result in insufficient cooling and heating capacity.
 - Press the Fan button (), MODE button, ON/OFF or ECO button will cancel the Silent function.
- 5 **FAN Button** ()
Used to select the fan speed in four steps: AUTO → LOW → MED → HIGH
You can not switch the fan speed in AUTO or DRY mode.
NOTE:
 - Hold down this button for at least 2 seconds to activate/cancel **Turbo** mode. Turbo function enables the unit to reach the preset temperature at cooling or heating operation in the shortest time (if the indoor unit does not support this function, there is no corresponding operation happened when pressing this button.)

Operation of buttons

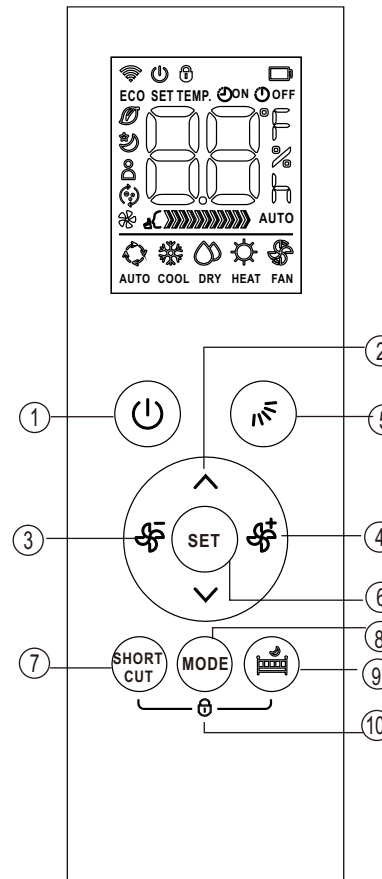

- 5 **Swing Button** ()
(applicable to RG58A2/RG58B2/RG58A4)
Used to stop or start horizontal louver movement. Hold down this button for 2 seconds to start/stop vertical louver movement.

Swing Button () (applicable to RG57B1)
Used to stop or start horizontal louver movement or set the desired up/down air flow direction. The louver can be move at a range of about 6° each time you press the button. If keep pushing more than 2 seconds, the louver will swing up and down automatically.
- 6 **SET Button**
Used to initiate the following functions in the sequence below, in conjunction with the & buttons.

```

    graph TD
      A[Timer on] --> B[Timer off]
      B --> C[Self clean*]
      C --> D[Follow me*]
      D --> E[Sleep*]
      E --> F[Fresh*]
      F --> A
    
```

 (* Indicate optional functions)
 Press the SET button to select the desired function, the selected symbol will flash on the display area, then press the or button to confirm.
- 7 **SLEEP function** ()
It can maintain the most comfortable temperature and save energy. This function is available on COOL, HEAT or AUTO mode only. For the detail, see "sleep operation" in "USER'S MANUAL".
- 8 *** FRESH function** () (optional)
When the FRESH function is initiated, the Ionizer/Plasma Dust Collector (depending on models) is energized and will help to remove pollen and impurities from the air.
- 9 *** SELF CLEAN function** () (optional)
Under SELF CLEAN mode, the air conditioner will automatically clean and dry the Evaporator and keep it as fresh for the next operation.

Operation of buttons

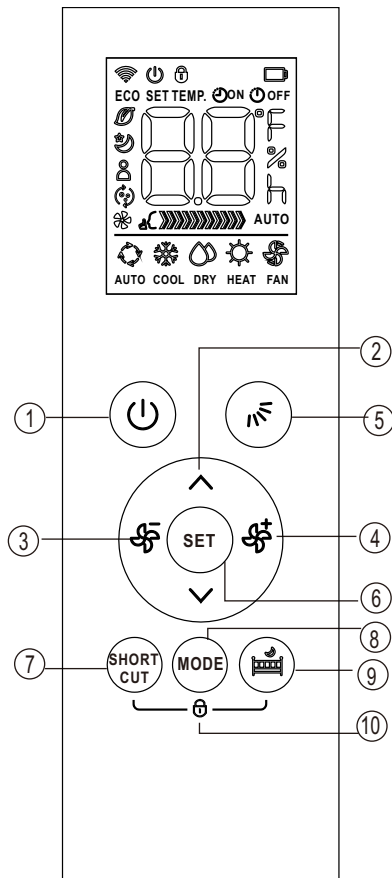

* FOLLOW ME function()(optional)

When the Follow Me function is activated, the remote display is actual temperature at its location. The remote control will send this signal to the air conditioner every 3 minutes interval until press the FOLLOW ME button again.

⑦ SHORTCUT Button

- Used to restore the current settings or resume previous settings.
- On the first time connecting to the power, if push the SHORTCUT button, the unit will operate on AUTO mode, 26°C, and fan speed is Auto.
- Push this button when remote controller is on, the system will automatically revert back to the previous settings including operating mode, setting temperature, fan speed level and sleep feature(if activated).
- If pushing more than 2 seconds, the system will automatically restore the current operation settings including operating mode, setting temperature, fan speed level and sleep feature(if activated).

⑧ MODE Button

Press this button to modify the air conditioner mode in a sequence of following:

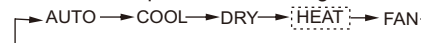

NOTE: Please do not select HEAT mode if the machine you purchased is cooling only type. Heat mode is not supported by the cooling only appliance.

⑨ DO NOT DISTURB Button()

Press this button to turn off the indoor screen display, and also turn off the Air conditioner buzzer, the fan speed shifts to low, which create a comfortable and quiet environment. Press it again to cancel this function. Under DO NOT DISTURB mode, the display will illuminate for 10 seconds while adjusting the mode, set temperature or fan speed, etc.

⑩ LOCK Function







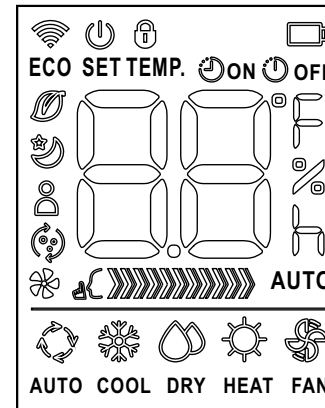









Press button ECO and  simultaneously to lock or unlock the keyboard.

Indicators on LCD









Information are displayed when the remote controller is powered up.



Mode display

				
AUTO	COOL	DRY	HEAT	FAN
	Displayed when data transmitted.			
	Displayed when remote controller is ON.			
	Battery display(low battery detection)			
	Indicated LOCK feature is activated			
ECO	Displayed in ECO mode operation			
	Displayed when TIMER ON time is set.			
	Displayed when TIMER OFF time is set.			
	Show set temperature or room temperature, or time under TIMER setting.			
	Indicated that the air conditioner is operating in Follow me mode			
	Displayed in Fresh operation.			
	Displayed in Self clean operation.			
	Displayed when Silent feature is activated			
	Displayed in Sleep Mode operation.			

Fan speed indication

		Low speed
		Medium speed
		High speed
		AUTO Auto fan speed

Note:

All indicators shown in the figure are for the purpose of clear presentation. But during the actual operation only the relative functional signs are shown on the display window.

How to use the buttons

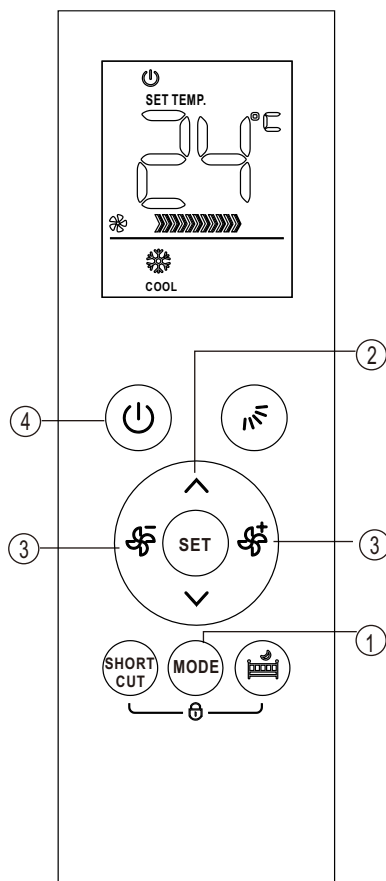

Auto operation

Ensure the unit is plugged in and power is available. The OPERATION indicator on the display panel of the indoor unit starts flashing.

1. Press the **MODE** button to select Auto.
2. Press the **UP/DOWN** button to set the desired temperature. The temperature can be set within a range of 17°C~ 30°C in 1°C increments.
3. Press the **ON/OFF** button to start the air conditioner.

NOTE

1. In the Auto mode, the air conditioner can logically choose the mode of Cooling, Fan, and Heating by sensing the difference between the actual ambient room temperature and the setting temperature on the remote controller.
2. In the Auto mode, you can not switch the fan speed. It has already been automatically controlled.
3. If the Auto mode is not comfortable for you, the desired mode can be selected manually.

Cooling /Heating/Fan operation

Ensure the unit is plugged in and power is available.

1. Press the **MODE** button to select COOL, HEAT(cooling & heating models only) or FAN mode.
2. Press the **UP/DOWN** buttons to set the desired temperature. The temperature can be set within a range of 17°C~ 30°C in 1°C increments.
3. Press the **FAN** button to select the fan speed in four steps- Auto, Low, Med, or High.
4. Press the **ON/OFF** button to start the air conditioner.

NOTE

In the FAN mode, the setting temperature is not displayed in the remote controller and you are not able to control the room temperature either. In this case, only step 1, 3 and 4 may be performed.

How to use the buttons

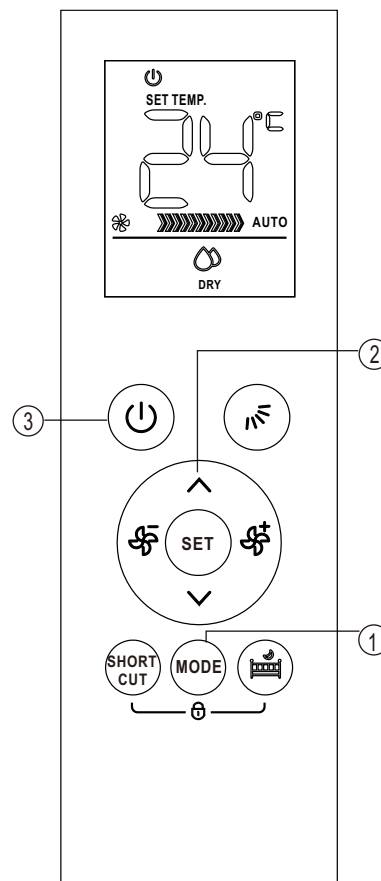

Dehumidifying operation

Ensure the unit is plugged in and power is available. The OPERATION indicator on the display panel of the indoor unit starts flashing.

1. Press the **MODE** button to select DRY mode.
2. Press the **UP/DOWN** buttons to set the desired temperature. The temperature can be set within a range of 17°C~ 30°C in 1°C increments.
3. Press the **ON/OFF** button to start the air conditioner.

NOTE

In the Dehumidifying mode, you can not switch the fan speed. It has already been automatically controlled.

Timer operation

Press the SET button can set the auto-on/off time of the unit.

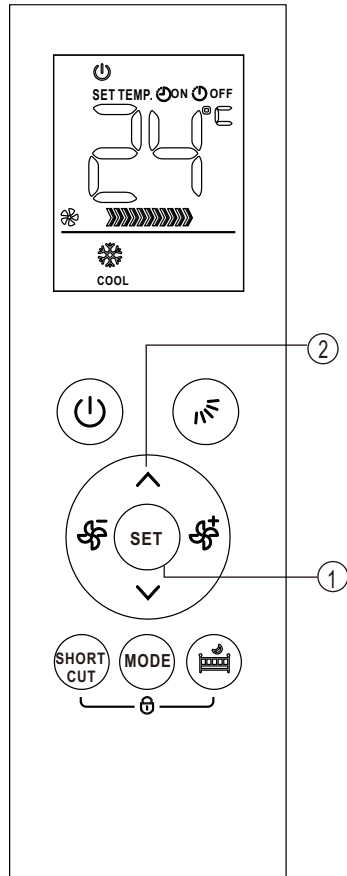

To set the Auto-on time.

1. Press the SET button, the Timer on indicator "ON" displays and flashes, the last Auto-on setting time and the signal "h" will be shown on the LCD display area. Now it is ready to reset the Auto-on time to START the operation.
2. Press the \wedge or \vee button to set desired Auto-on time. Each time you press the button, the time increases/decreases by half an hour between 0 and 10 hours and by one hour between 10 and 24 hours.
3. Once the desired time establishes, there will be three seconds delay before the remote controller transmits the signal to the air conditioner. Then, the signal "h" will disappear, the Timer on indicator will remain on and the set temperature will re-appear on the LCD display window.

To set the Auto-off time.

1. Press the SET button until the Timer on indicator "OFF" displays and flashes, the last Auto-off setting time and the signal "h" will be shown on the LCD display area. Now it is ready to reset the Auto-off time to STOP the operation.
2. Press the \wedge or \vee button to set desired Auto-off time. Each time you press the button, the time increases/decreases by half an hour between 0 and 10 hours and by one hour between 10 and 24 hours.
3. Once the desired time establishes, there will be three seconds delay before the remote controller transmits the signal to the air conditioner. Then, the signal "h" will disappear, Timer off indicator will remain on and the set temperature will re-appear on the LCD display window.

CAUTION

- When you select the timer operation, the remote controller automatically transmits the timer signal to the indoor unit for the specified time. Therefore, keep the remote controller in a location where it can transmit the signal to the indoor unit properly.
- The effective operation time set by the remote controller for the timer function is limited to the following settings: 0.5, 1.0, 1.5, 2.0, 2.5, 3.0, 3.5, 4.0, 4.5, 5.0, 5.5, 6.0, 6.5, 7.0, 7.5, 8.0, 8.5, 9.0, 9.5, 10, 11, 12, 13, 14, 15, 16, 17, 18, 19, 20, 21, 22, 23 and 24.

Example of timer setting

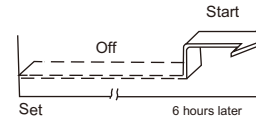

TIMER ON (Auto-on Operation)

The TIMER ON feature is useful when you want the unit to turn on automatically before you return home. The air conditioner will automatically start operating at the set time.

Example:

To start the air conditioner in 6 hours.

1. Press the SET button to select TIMER ON, the last setting of starting operation time and the signal "h" will show on the display area.
2. Press the \wedge or \vee button to display "6.0h" on the TIMER ON display of the remote controller.
3. Wait for three seconds and the digital display area will show the temperature again. The "ON" indicator remains on and this function is activated.

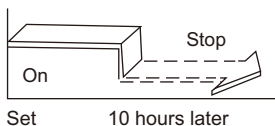

TIMER OFF

(Auto-off Operation)

The TIMER OFF feature is useful when you want the unit to turn off automatically after you go to bed. The air conditioner will stop automatically at the set time.

Example:

To stop the air conditioner in 10 hours.

1. Press the SET button to select TIMER OFF, the last setting of stopping operation time and the signal "h" will show on the display area.
2. Press the \wedge or \vee button to display "10h" on the TIMER OFF display of the remote controller.
3. Wait for three seconds and the digital display area will show the temperature again. The "OFF" indicator remains on and this function is activated.

COMBINED TIMER

(Setting both ON and OFF timers simultaneously)

TIMER OFF \rightarrow TIMER ON

(On \rightarrow Stop \rightarrow Start operation)

This feature is useful when you want to stop the air conditioner after you go to bed, and start it again in the morning when you wake up or when you return home.

Example:

To stop the air conditioner 2 hours after setting and start it again 10 hours after setting.

1. Press the SET button to select TIMER OFF.
2. Press the \wedge or \vee button to display 2.0h on the TIMER OFF display.
3. Press the SET button to select TIMER ON.
4. Press the \wedge or \vee button to display 10h on the TIMER ON display.
5. Wait for three seconds and the digital display area will show the temperature again. The "ON & OFF" indicators remain on and this function is activated.

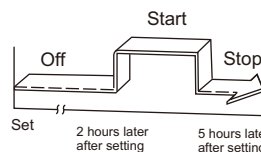

TIMER ON \rightarrow TIMER OFF

(Off \rightarrow Start \rightarrow Stop operation)

This feature is useful when you want to start the air conditioner before you wake up and stop it after you leave the house.

Example:

To start the air conditioner 2 hours after setting, and stop it 5 hours after setting.

1. Press the SET button to select TIMER ON.
2. Press the \wedge or \vee button to display 2.0h on the TIMER ON display.
3. Press the SET button to select TIMER OFF.
4. Press the \wedge or \vee button to display 5.0h on the TIMER OFF display.
5. Wait for three seconds and the digital display area will show the temperature again. The "ON & OFF" indicators remain on and this function is activated.

Handling the remote controller

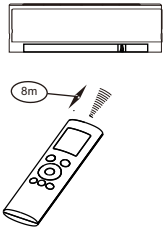

Location of the remote controller.

- Use the remote controller within a distance of 8 meters from the appliance, pointing it towards the receiver. Reception is confirmed by a beep.

⚠ CAUTIONS

- The air conditioner will not operate if curtains, doors or other materials block the signals from the remote controller to the indoor unit.
- Prevent any liquid from falling into the remote controller. Do not expose the remote controller to direct sunlight or heat.
- If the infrared signal receiver on the indoor unit is exposed to direct sunlight, the air conditioner may not function properly. Use curtains to prevent the sunlight from falling on the receiver.
- If other electrical appliances react to the remote controller, either move these appliances or consult your local dealer.
- Do not drop the remote controller. Handle with care.
- Do not place heavy objects on the remote controller, or step on it.

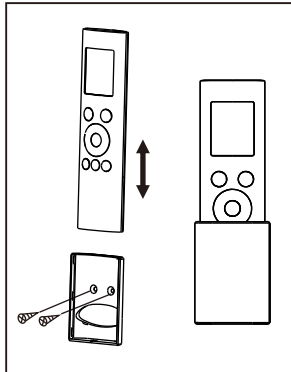

(1)

Using the remote controller holder (optional)

- The remote controller can be attached to a wall or pillar by using a remote controller holder(not supplied, purchased separately).
- Before installing the remote controller, check that the air conditioner receives the signals properly.
- Install the remote controller with two screws.
- For installing or removing the remote controller, move it up or down in the holder.

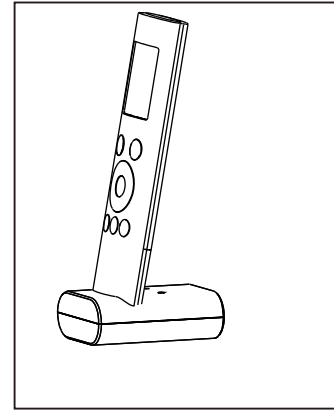

(2)

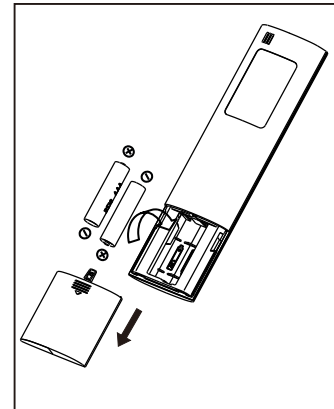

Replacing batteries

The following cases signify exhausted batteries. Replace old batteries with new ones.

- Receiving beep is not emitted when a signal is transmitted.
- Indicator fades away.

The remote controller is powered by two dry batteries (R03/LR03X2) housed in the back rear part and protected by a cover.

- (1) Remove the cover in the rear part of the remote controller.
- (2) Remove the old batteries and insert the new batteries, placing the (+) and (-) ends correctly.
- (3) Install the cover back on.

NOTE: When the batteries are removed, the remote controller erases all programming. After inserting new batteries, the remote controller must be reprogrammed.

⚠ CAUTIONS

- Do not mix old and new batteries or batteries of different types.
- Do not leave the batteries in the remote controller if they are not going to be used for 2 or 3 months.
- Do not dispose batteries as unsorted municipal waste. Collection of such waste separately for special treatment is necessary.