

INSTALLATION & OWNER'S MANUAL

Control Box Type

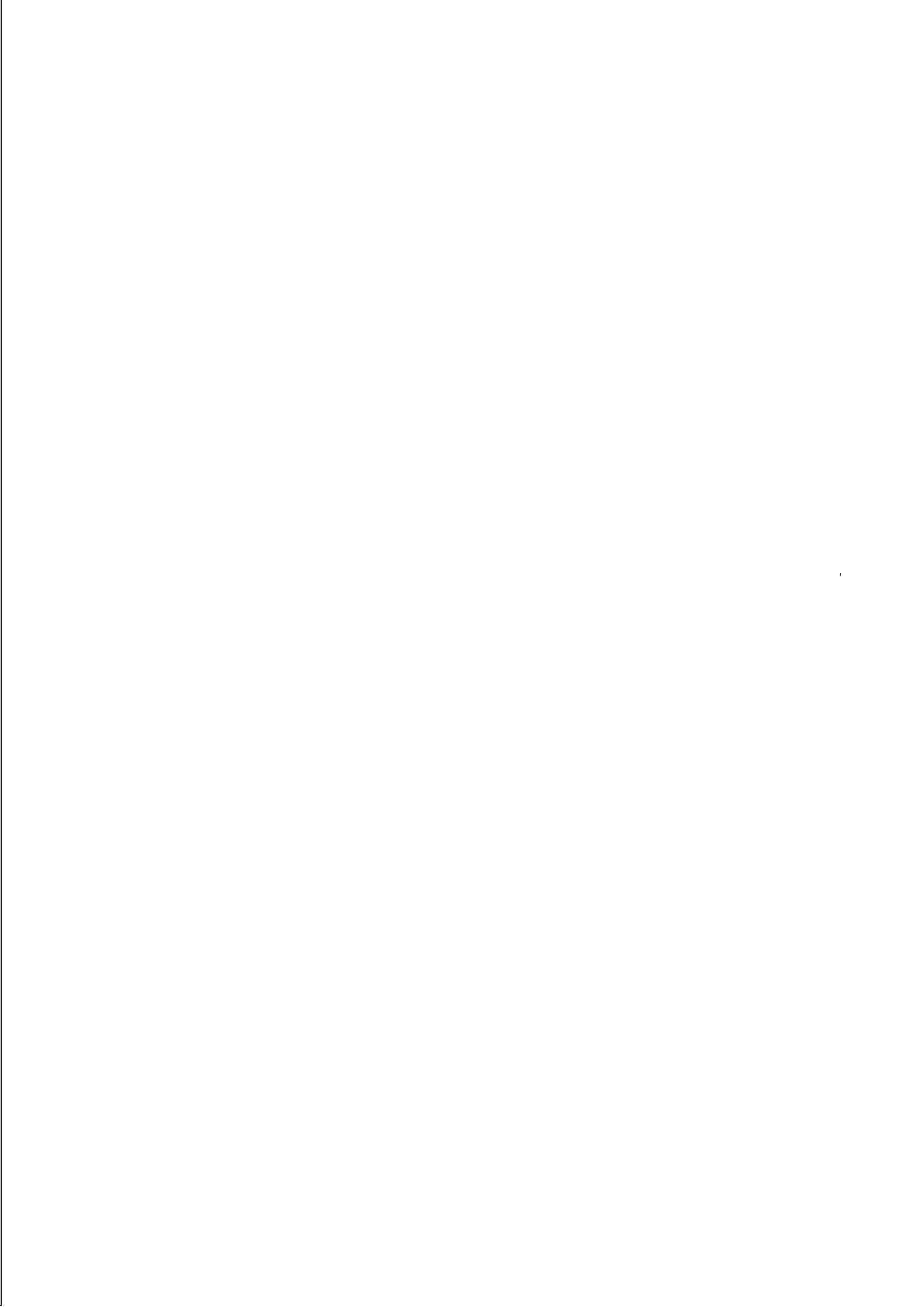

PRECAUTIONS.....	1
INSTALLATION INFORMATION.....	2
ATTACHED FITTINGS.....	3
INSTALLATION METHOD&DIMENSION.....	4
MATERIAL AND SIZE OF THE PIPING.....	5
ELECTRICAL WIRING.....	5
APPLICALTION CONTROL.....	7
TROUBLE SHOOTING.....	9

1. PRECAUTIONS

- Be sure to be in conformity with the local, national and international laws and regulations.
- Read "PRECAUTIONS" carefully before installation.
- The following precautions include important safety items. Observe them and never forget.
- Keep this manual in a handy place for future reference.

The safety precautions listed here are divided into two categories. In either case, important safety information is listed which must be read carefully.



WARNING

Failure to observe a warning may result in death.



CAUTION

Failure to observe a caution may result in injury or damage to the equipment.

After completing the installation, make sure that the unit operates properly during the start-up operation. Please instruct the customer on how to operate the unit and keep it maintained. Also, inform customers that they should store this installation manual for future reference.



WARNING

Be sure only trained and qualified service personnel to install, repair or service the equipment.

Improper installation, repair, and maintenance may result in electric shocks, short-circuit, leaks, fire or other damage to the equipment.

Install according to this installation instructions strictly.

If installation is defective, it will cause water leakage, electric shock, fire.

When installing the unit in a small room, take measures against to keep refrigerant concentration from exceeding allowable safety limits in the event of refrigerant leakage. Contact the place of purchase for more information. Excessive refrigerant in a closed ambient can lead to oxygen deficiency.

Use the attached accessories parts and specified parts for installation.

otherwise, it will cause the set to fall, water leakage, electric shock, fire.

Install at a strong and firm location which is able to withstand the set's weight.

If the strength is not enough or installation is not properly done, the set will drop to cause injury.

Before obtaining access to terminals, all supply circuits must be disconnected.

The appliance must be positioned so that the plug is accessible.

The enclosure of the appliance shall be marked by word, or by symbols, with the direction of the fluid flow.

For electrical work, follow the local national wiring standard, regulation and this installation instructions. An independent circuit and single outlet must be used.

If electrical circuit capacity is not enough or defect in electrical work, it will cause electric shock, fire.

Use the specified cable and connect tightly and clamp the cable so that no external force will be acted on the terminal.

If connection or fixing is not perfect, it will cause heat-up or fire at the connection.

Wiring routing must be properly arranged so that control board cover is fixed properly.

If control board cover is not fixed perfectly, it will cause heat-up at connection point of terminal, fire or electric shock.

If the supply cord is damaged, it must be replaced by the manufacture or its sevice agent or similarly qualifued person in order to avoid a hazard.

An all-pole disconnection switch having a cintract separation of at least 3mm in a poles should be connected in fixed wiring.

When carrying out piping connection, take care not to let air substances go into refrigeration cycle.

Otherwise, it will cause lower capacity, abnormal high pressure in the refrigeration cycle, explosion and injury.

Do not modify the length of the power supply cord or use of extension cord, and do not share the single outlet with other electrical appliances.

Otherwise, it will cause fire or electric shock.

Carry out the specified installation work after taking into account strong winds, typhoons or earthquakes.

Improper installation work may result in the equipment falling and causing accidents.

If the refrigerant leaks during installation, ventilate the area immediately.

Toxic gas may be produced if the refrigerant comes into the place contacting with fire.

After completing the installation work, check that the refrigerant does not leak.

Toxic gas may be produced if the refrigerant leaks into the room and comes into contact with a source of fire, such as a fan heater, stove or cooker.



CAUTION

Ground the air conditioner.

Do not connect the ground wire to gas or water pipes, lightning rod or a telephone ground wire. Incomplete grounding may result in electric shocks.

Be sure to install an earth leakage breaker.

Failure to install an earth leakage breaker may result in electric shocks.

Connect the outdoor unit wires , then connect the indoor unit wires.

You are not allow to connect the air conditioner with the power source until w(including iring and piping the air conditioner is done.

While following the instructions in this installation manual, install drain piping in order to ensure proper drainage and insulate piping in order to prevent condensation.

Improper drain piping may result in water leakage and property damage.

Install the indoor and outdoor units, power supply wiring and connecting wires at least 1 meter away from televisions or radios in order to prevent image interference or noise.

Depending on the radio waves, a distance of 1 meter may not be sufficient enough to eliminate the noise.

The appliance is not intended for use by young children or infirm persons without supervision.

Young children should be supervised to ensure that they do not play with the appliance.

Don't install the air conditioner in the following locations:

- There is petrolatum existing.
- There is salty air surrounding (near the coast).
- There is caustic gas (the sulfide, for example) existing in the air (near a hot spring).
- The Volt vibrates violently (in the factories).
- In buses or cabinets.
- In kitchen where it is full of oil gas.
- There is strong electromagnetic wave existing.
- There are inflammable materials or gas.
- There is acid or alkaline liquid evaporating.
- Other special conditions.

2. INSTALLATION INFORMATION

- **To install properly, please read this "installation manual" at first.**
- **The air conditioner must be installed by qualified persons.**
- **When installing the indoor unit or its tubing, please follow this manual as strictly as possible.**
- **If the air conditioner is installed on a metal part of the building, it must be electrically insulated according to the relevant standards to electrical appliances.**
- **When all the installation work is finished, please turn on the power only after a thorough check.**
- **Regret for no further announcement if there is any change of this manual caused by product improvement.**







INSTALLATION ORDER

- Select the location;
- Install the indoor unit;
- Install the outdoor unit;
- Install the connecting pipe ;
- Connect the drain pipe;
- Wiring;
- Test operation.

3. ATTACHED FITTINGS

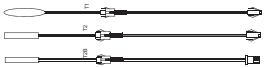
Please check whether the following fittings are of full scope. If there are some spare fittings , please restore them carefully.

Table.3-1

NAME	SHAPE	QUANTITY	FUNCTION
1. Screw ST3.9x25 for installation board		4	Secure the installation board
2. Plastic expanded tube		8	_____
3. Temp.sensor (AHUKZ-01 only)		3	_____
4. Temp.sensor (AHUKZ-02 only)	 X2	6	_____
5. Display panel connecting wire group		1	_____
6. Wire controller connecting wire group		1	_____
7. Installation&owner's manual	_____	2	_____
8. Wire controller installation manual	_____	1	_____

4. INSTALLATION METHOD & DIMENSION

AHUKZ-01
AHUKZ-02

Units: mm

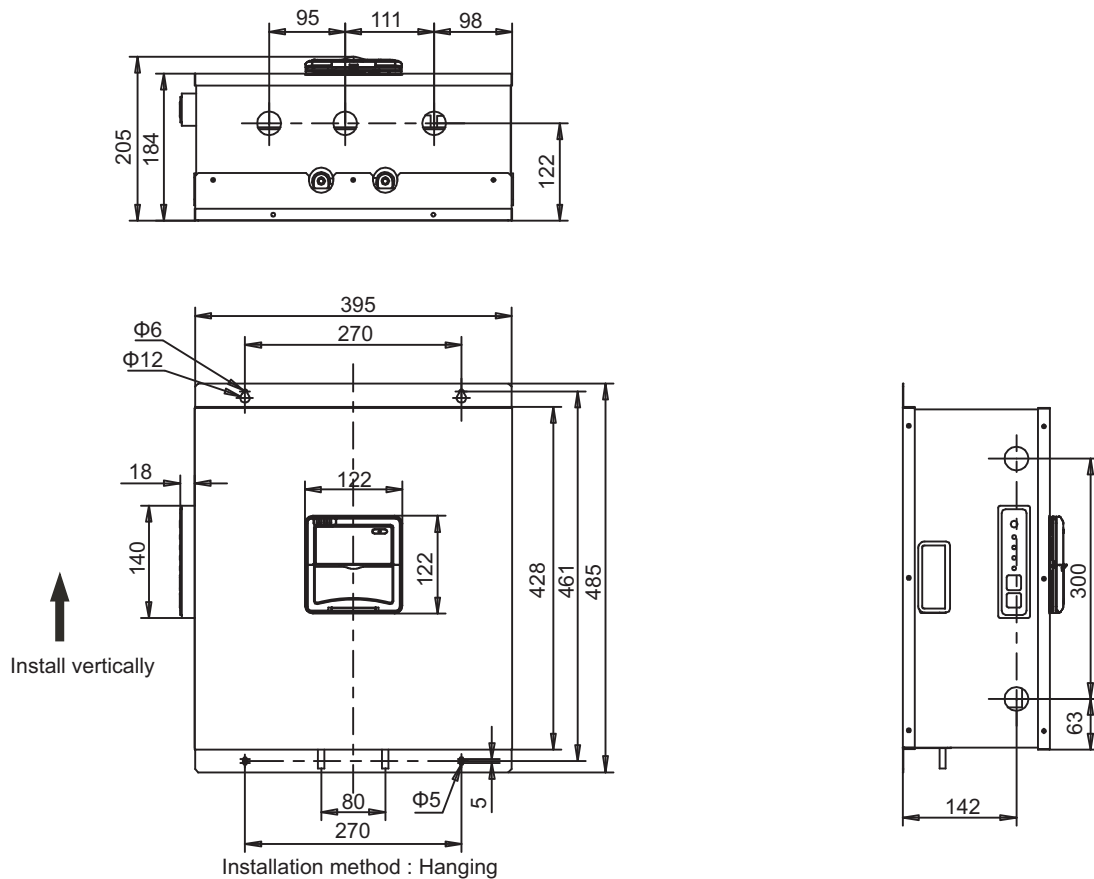

Fig.4-1

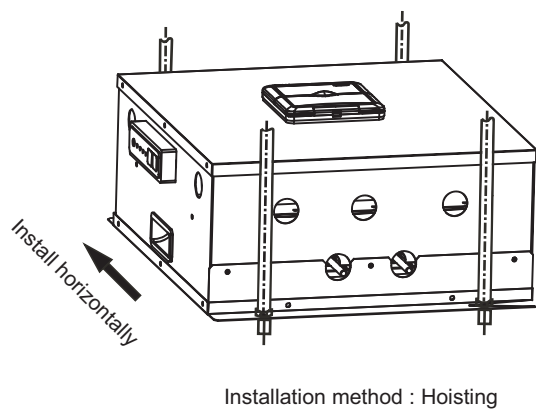

Fig.4-2

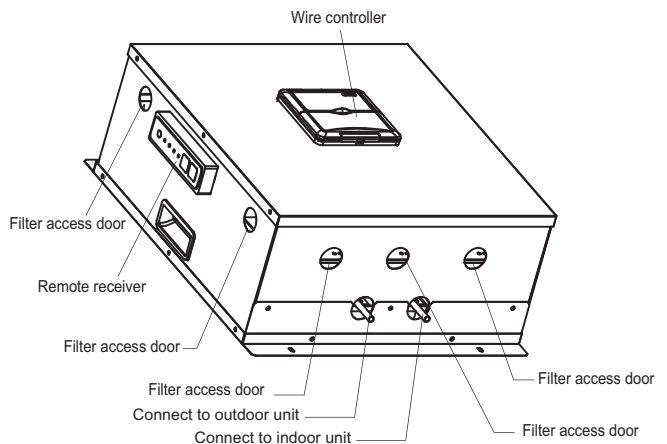

Fig.4-3



NOTE

- 1 As hanging installation please use Screw ST3.9x25 for installation.
- 2 As hanging installation, the box should be vertical, and as hoisting installation, it should be installed horizontally, and prohibit to be sloped, inverted.
- 3 Please refer to the foregoing, make sure the laying direction of the refrigerant pipe and the connecting place of the connecting wire.
- 4 All the pictures in this manual are for explanation purpose only. They may be slightly different from the air conditioner you purchased (depend on model). The actual shape shall prevail.

5. MATERIAL AND SIZE OF THE PIPING



CAUTION

- 1 The connecting distance of control box and indoor unit should not more than 5 m.
- 2 This control box can only connect to R410A refrigerant system.
- 3 During the installation of connecting pipes, do not let air, dust, or other sundries enter to the piping system.
- 4 Install the connecting pipe only after the indoor and outdoor units have been fixed.
- 5 When installing the connecting pipes, it must be kept dry and do not let water enter to the piping system.
- 6 The connecting copper pipes should be wrapped with thermal insulation materials (the thick should be more than 10mm; the close wet area should be thicken properly).

Table.5-1

Pipe Material		Copper Pipe for Air Conditioner	
Model		AHUKZ-01	AHUKZ-02
Size(mm)			
	(Liquid side)	Φ8	Φ12.7

6. ELECTRICAL WIRING



CAUTION

- 1 The air conditioner should use separate power supply with rated voltage.
- 2 The external power supply to the air conditioner should have ground wiring, which is linked to the ground wiring of the indoor and outdoor unit.
- 3 The wiring work should be done by qualified persons according to circuit drawing.
- 4 The fixed connecting lines must equip with at least 3mm electric shock spacing.
- 5 A leakage protector should be installed according to the National Standard concerning electrical appliance.
- 6 Be sure to locate the power wiring and the signal wirings well to avoid cross-disturbance and their contact with connecting pipe or stop value body. Generally, do not twist two wiring together unless the joint is soldered well and covered with insulator tape.
- 7 Do not turn on the power until you have checked carefully after wiring.

6-1 The specification of power

The specification of power as the follow display figure, if the capacity is too small will lead to over heat of the wiring, and cause burning of the machine accident.

Table.6-1

Model		AHUKZ-01	AHUKZ-02
Power	Phase	Single-phase	
	Voltage and Frequency	220-240V ~ 50Hz 208-230V ~ 60Hz	



CAUTION

The air-gap notch in the circuit breaker is used for insulating the flexible conductor, so that must respond to the related national wire requests to connect to the fixed circuit.

6-2 Terminal block setting figure

Please refer to the indoor unit wiring figure for connecting wire.



CAUTION

The air-conditioner can connect to the central controller (CCM). Before the operation, please correctly connect the wire and well set the system address and network address of indoor unit.

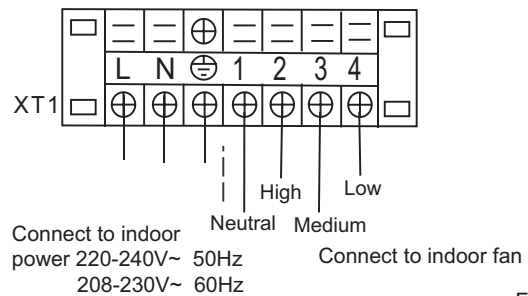

Fig.6-1

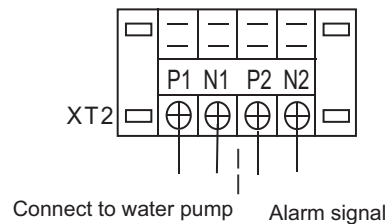

Fig.6-2

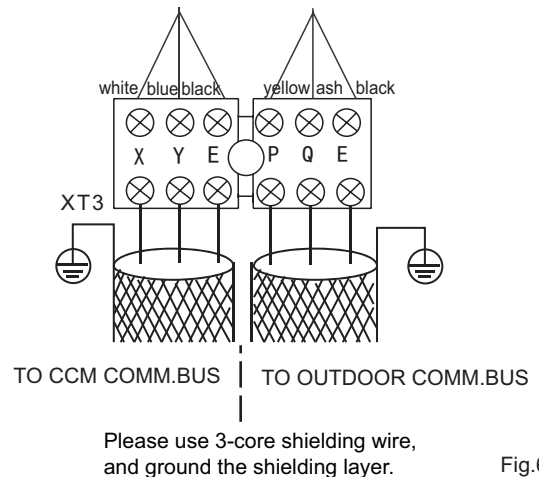

Fig.6-3

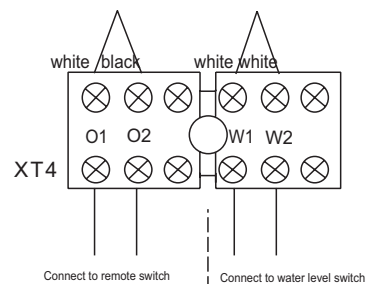
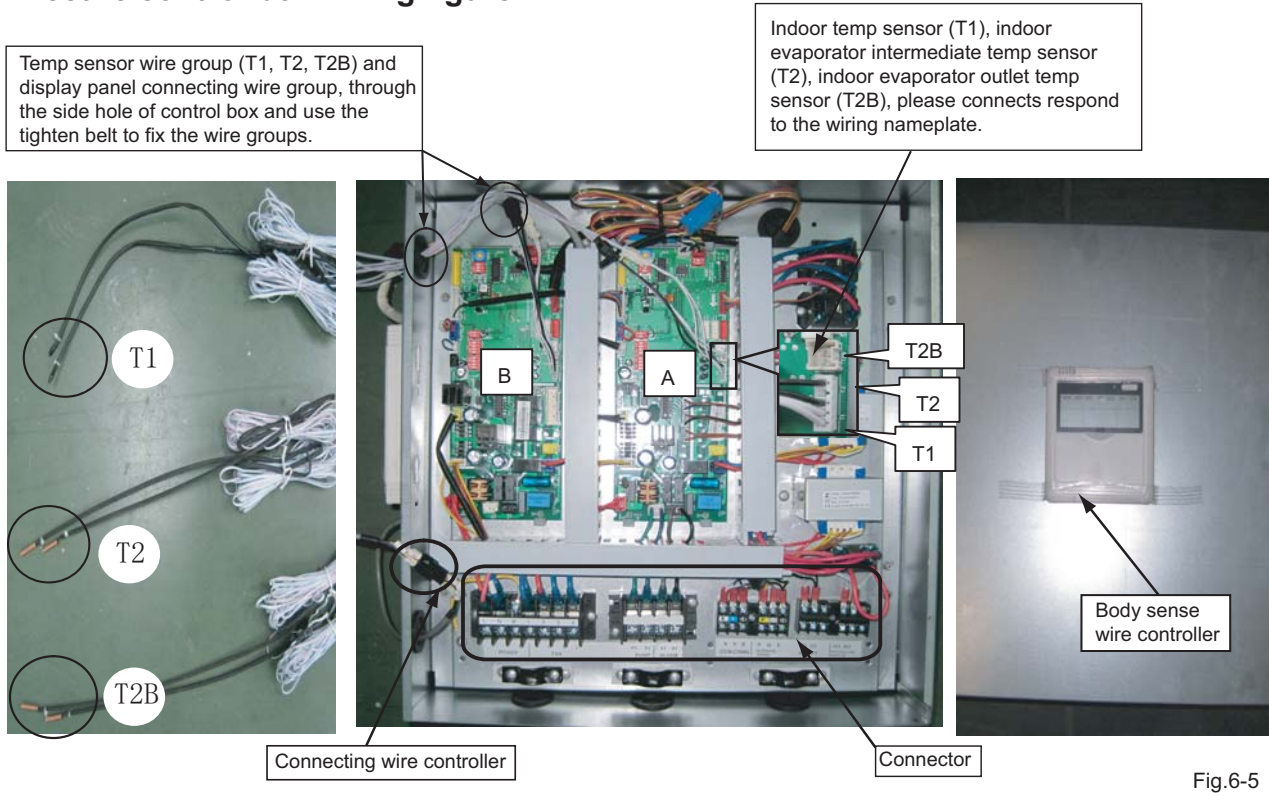

Fig.6-4

6-3 Electric control box wiring figure



CAUTION

- 1 AHUKZ-01 adopts one master control board, AHUKZ-02 adopts two master control boards, when installing, both the two master control boards of AHUKZ-02 should connect to the temp sensor T1, T2 and T2B, and place the corresponding two sensors of the two master control boards in the same location.
- 2 T1 is indoor temperature sensor, install to the air inlet of the indoor unit.
- 3 T2 is indoor evaporator intermediate temperature sensor, install to the intermediate of temperature evaporatorz.
- 4 T2B is indoor evaporator outlet sensor, install to the outlet of the evaporator.

6-4 Indoor and outdoor unit wiring figure

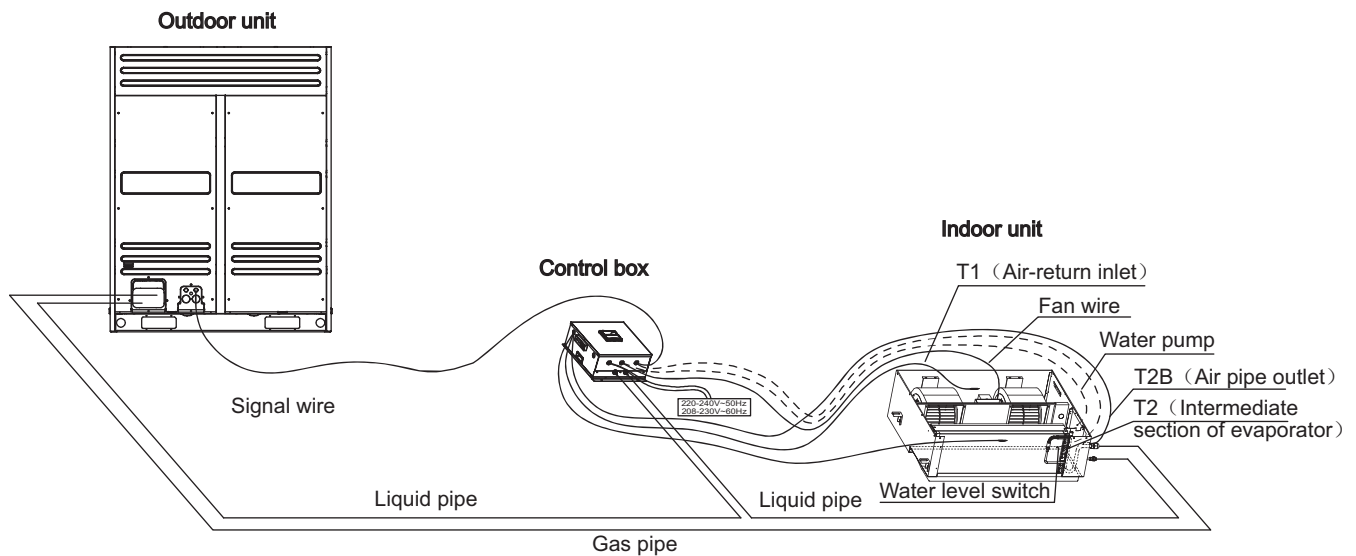

CAUTION

If it is needed, user can select the backup function in the dotted line frame.

7. APPLICATION CONTROL

7-1 Application control

Set the PCB code of the indoor unit electric control box by different usage. After setting, be sure to turn off the total power switch again and then switch on again. The setting function can not be carried out if not to turn off the total power switch again and then switch on again (Fig.7-1).

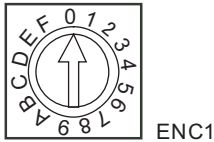

Fig.7-1

- Function specification:

ENC1—Cooling capacity setting, set the cooling capacity of this machine (Table. 7-1).

Table.7-1

ENC1	Toggle switch	For setting cooling capacity
Caution: The horsepower has been set before leaving the factory; anyone can't modify it except the maintenance person.	Code	Setting cooling capacity
	0	2200W(0.8HP)
	1	2800W(1.0HP)
	2	3600W(1.3HP)
	3	4500W(1.6HP)
	4	5600W(2.0HP)
	5	7100W(2.5HP)
	6	8000W(3.0HP)
	7	9000W(3.2HP)
	8	11200W(4.0HP)
9	14000W(5.0HP)	

7-2 System Address and Network Address Setting

- 1) The default system address is "00" for AHUKZ-01, "00" and "01" for system A and B of AHUKZ-02 respectively.
- 2) If there are several indoor units multi-connected, the system address may be conflict between the different units. In that case, reset the in door unit's address is needed.
- 3) If the system address conflict occur, the indoor units must use remote controller to set the system address first (For setting system address to the indoor unit with two or more master boards, it have to use display panel with 10-core wire to connect the display panel, and address setting for every master board respectively).

4) Communicating the indoor and outdoor units to finish setting network address, its address is the same as the indoor unit address, no need to setting separately.

5) When all the indoor units are AHUKZ-01/AHUKZ-02 or V4+ series indoor units, centralized control of indoor unit can finish upside the outdoor unit, no need to do the centralized control inside the indoor unit, the detailed instruction refers to V4+ Outdoor Unit Instruction.

6) For the previous indoor unit centralized control function, can connect to the (X,Y,E) terminals and form centralized control network, at that time no need to set the network address, then also can through the outlay network module, mainboard (CN20) and form a network.

7-3 Mainboard Code Indication Label

Definition of every SW1 position

Table.7-2

SW1 ON 1234	<ul style="list-style-type: none"> • 1 means the factory test mode • 0 automatic search address mode (factory default)
SW1 ON 1234	<ul style="list-style-type: none"> • 1 means the factory test mode • 0 means select AC fan
SW1 ON 1234	<ul style="list-style-type: none"> • 00 means DC fan static pressure selection 0 set (reserved)

Table.7-3

SW1 ON 1234	<ul style="list-style-type: none"> • 01 means DC fan static pressure selection 1 set (reserved)
SW1 ON 1234	<ul style="list-style-type: none"> • 10 means DC fan static pressure selection 2 set (reserved)
SW1 ON 1234	<ul style="list-style-type: none"> • 11 means DC fan static pressure selection 3 set (reserved)

Definition of every SW2 position

Table.7-4

SW2 ON 1234	<ul style="list-style-type: none"> • 00 means temperature of shut down against cool air is 15°C
SW2 ON 1234	<ul style="list-style-type: none"> • 00 means temperature of shut down against cool air is 20°C
SW2 ON 1234	<ul style="list-style-type: none"> • 00 means temperature of shut down against cool air is 24°C
SW2 ON 1234	<ul style="list-style-type: none"> • 00 means temperature of shut down against cool air is 26°C

Table.7-5

	<ul style="list-style-type: none"> • 00 means the time of TERMAL stop the fan is 4 minutes
	<ul style="list-style-type: none"> • 00 means the time of TERMAL stop the fan is 8 minutes
	<ul style="list-style-type: none"> • 00 means the time of TERMAL stop the fan is 12 minutes
	<ul style="list-style-type: none"> • 00 means the time of TERMAL stop the fan is 16 minutes

Definition of every SW5 position

Table.7-6

	<ul style="list-style-type: none"> • 00 means the temperature compensation under heating mode is 6°C
	<ul style="list-style-type: none"> • 01 means the temperature compensation under heating mode is 2°C

Table.7-7

	<ul style="list-style-type: none"> • 10 means the temperature compensation under heating mode is 4°C
	<ul style="list-style-type: none"> • 11 means the temperature compensation under heating mode is 8°C

Definition of every SW6 position

Table.7-8

	<ul style="list-style-type: none"> • 1 means the old display panel • 0 means the new display panel
	<ul style="list-style-type: none"> • 1 means automatic mode automatic fan • 0 means non-automatic mode automatic fan
	Reserved

Definition of J1,J2 positions

Table.7-9

	J1 Jumperless for has power down memory function
	J1 Jumperless for has no power down memory function
	Reserved

Definition of every SW7 position

Table.7-10

	Standard configuration
	The last set of the network

Definition of every 0/1 code

Table.7-11

	Means 0
	Means 1



CAUTION

- Please adjust the code ENC1 to the proper position (both the AHUKZ-02 model system A and system B should be adjusted)
For AHUKZ-01 model:
9kW please set the main board's code ENC1 in the electric controller to 7;
11.2kW please set the main board's code ENC1 in the electric controller to 8;
14kW please set the main board's code ENC1 in the electric controller to 9.

For AHUKZ-02 model:
20kW please set two main boards' code ENC1 in the electric controller to 8;
25kW please set one main board's code ENC1 in the electric controller to 8, and set the another code ENC1 to 9;
28kW please set two main boards' code ENC1 in the electric controller to 9.
- For the same indoor unit, each main board must has different indoor unit addresses and network addresses.
- When use centralized controller to control indoor unit, and set address for the AHUKZ-02 with two or more main boards, we suggest that set the neighbor address for the same main board of indoor unit. When use centralized controller for controlling, main board in the same indoor unit must ON and OFF at the same time, for avoiding that affect the usage function of the machine.

8. TROUBLE SHOOTING

Table.8-1

NO.	Type	Contents	LED Display	Remarks
1	Malfunction	The evaporator sensor check point is abnormal or room temp. sensor is abnormal.	Error code "H1,H2,H3, E2,E3 or E4"	After the malfunctions disappear, it restores automatically.
2	Malfunction	Indoor/outdoor unit communication is abnormal.	Error code "E1"	After the malfunctions disappear, it restores automatically.
3	Malfunction	Condenser sensor check point is abnormal or outdoor temp.	Error code "Ed "	After the malfunctions disappear, it restores automatically.
4	Malfunction	Water level switch is abnormal	Error code "EE"	If the malfunctions can't be solved in three min. all the indoor alarm lamps flash at 0.5Hz. Turn off the power to restore.
5	Alarm	Mode conflict	Error code "E0"	When the indoor unit turns to heating mode or is turned off, the alarm will disappear.

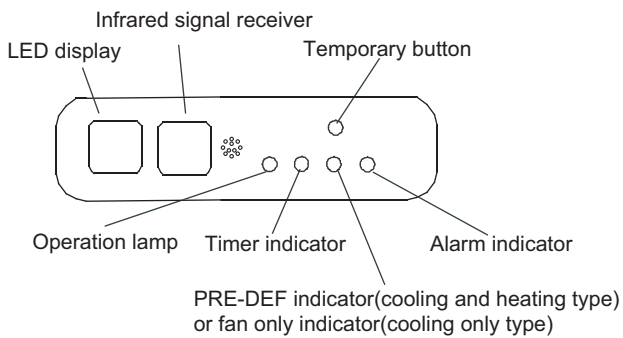

Fig.8-1

MDV11IU-001BW

202000171586

